

Contents	Descriptions	Page
<b>General Information</b>		
	<ul style="list-style-type: none"> <li>• Features and Benefits</li> <li>• Product Illustrations</li> </ul>	2 - 3
<b>General Duty, Light Duty Safety Switches &amp; Air Conditioning Disconnects</b>		
	<ul style="list-style-type: none"> <li>• 120/240Vac</li> </ul>	4 - 5
<b>Heavy Duty Safety Switches</b>		
	<ul style="list-style-type: none"> <li>• 240Vac Fusible</li> <li>• 600Vac Fusible &amp; Non-Fusible</li> </ul>	6 - 7 8 - 11
<b>Heavy Duty Special Application Safety Switches</b>		
	<ul style="list-style-type: none"> <li>• 600Vac Fusible &amp; Non-Fusible</li> <li>• MD Motor Disconnect Switches</li> <li>• RCD Switches</li> </ul>	12 - 13 14 15
<b>Heavy Duty Receptacle Switches</b>		
	<ul style="list-style-type: none"> <li>• 600Vac Fusible &amp; Non-Fusible</li> </ul>	16
<b>1000 Vdc Photovoltaic Heavy Duty Disconnect Switch</b>		
	<ul style="list-style-type: none"> <li>• IEC and UL98-B listed</li> <li>• NEMA 3 and IP63 Enclosure</li> </ul>	17 17
<b>Double Throw Safety Switches</b>		
	<ul style="list-style-type: none"> <li>• 240Vac &amp; 600Vac Fusible &amp; Non-Fusible</li> </ul>	18 - 21
<b>Accessories (Field/Factory Installed)</b>		
	<ul style="list-style-type: none"> <li>• Heavy Duty Safety Switches</li> <li>• Double Throw Safety Switches - E-Series</li> <li>• Double Throw Safety Switches - F-Series</li> <li>• General Duty Safety Switches</li> </ul>	22 - 26 27 28 29
<b>Application Information</b>		
	<ul style="list-style-type: none"> <li>• Safety Switches Enclosures</li> </ul>	30

# Safety Switches

## General Information

### General Duty

- Pages:** DE2-4 to DE2-5
- Application:**
- Residential and light commercial.
  - 240 Vac maximum.
  - 30 through 600 Amperes.
  - Horsepower rated.
  - Short Circuit Ratings:
    - Plug Fuse - up to 10K RMS Symmetrical Amperes Fault Current
    - Class H, K Fuse - up to 10K RMS Symmetrical Amperes Fault Current
    - Class R, J Fuse - up to 100K RMS Symmetrical Amperes Fault Current
  - Service entrance rated.
- Standards:**
- CSA Certified under file numbers LL-89067 and LL-11815-108C
- Enclosures:**
- Types 1 and 3R
- Features:**
- Visible blades for positive indication that switch is "OFF".
  - Quick-Make / Quick-Break operating mechanism.
  - Lugs suitable for Al or Cu conductors.
  - Phenolic insulating bases.
  - Multiple padlock provisions in the "OFF" position.
  - Spring reinforced plated copper fuse clips.
- Accessories:**
- "RB Hubs" for Type 3R enclosures.
  - Class R fuse kits.
  - Factory or field installable electrical interlock on 60 - 200 Amperes (for F-Series only).
  - Field installed fuse pullers on 60 & 100 Amperes.
  - See page DE2-29 for more information regarding accessories and optional features.



### Heavy Duty

- Pages:** DE2-6 to DE2-11
- Application:**
- Commercial and industrial.
  - 600 Vac or 600 Vdc maximum.
  - 30 through 1200 Amperes.
  - Horsepower rated.
  - Short Circuit Ratings:
    - Class H, K Fuse - up to 10 K RMS Symmetrical Amperes Fault Current
    - Class J, R, L Fuse - up to 200 K RMS Symmetrical Amperes Fault Current
- Standards:**
- CSA Certified under file #'s LL-89067 and LL-97406-3.
- Enclosures:**
- Types 1, 3R, 4/4X and 3R/12
- Features:**
- In addition to General Duty....
- Red and black handles indicate switch position.
  - Dual cover interlock.
  - Terminations for copper or aluminum and for copper only.
- Accessories:**
- In addition to General Duty....
- Electrical interlocks factory or field installed.
  - Viewing Windows.
  - Factory or field installed fuse pullers.
  - Key interlock systems.
  - Factory installed push buttons.
  - Factory installed indicators of voltage presence on line/load side.
  - Lock-off guard.
  - Internal barrier kits.
  - See pages DE2-22 to DE2-26 for more information regarding accessories and optional features.





**Pages:** DE2-18 to DE2-21

**Application:**

- Manual transfer of a load between two power sources (or one power source between two loads on series A, F DT & DTU only)
- Residential, light commercial and industrial installations.
- Up to 600 Vac or 600 Vdc maximum.
- 30 through 600 Amperes.

**Standards:**

- cULus

**Enclosures:**

- Types 1, 3R, 4/4X and 12.

**Features:**

- Visible blades for positive indication switch is "OFF".
- Padlock provisions in the center "OFF" position.
- Padlock provisions in the "ON" positions
- Quick-Make / Quick-Break operating mechanism, Load-Make / Load-Break rated on Types DT & DTU (series A, F), 82,000.
- Dual cover interlock on the 82,000 line & A, F-Series devices with external defeat mechanism
- Series A, F, Types DT & DTU, supplied as standard for switching one load between two power sources, and may be field converted to switch one power source between two loads

**Accessories:**

- "RB" Bolt-on hubs for Type 3R enclosures.
- Field installable service grounding kits for Series E switches. Included as standard on Series F switches.
- Neutral assemblies and electrical interlocks are available for field installation only on series A, F, Types DT & DTU, 82,000.
- Factory installed indicators of voltage presence on line/load side(s) on Types DT & DTU (series F).
- See pages DE2-27 and DE2-28 for more information regarding accessories and optional features.

## Special Applications



**Pages:**

DE2-12 to DE2-14

- Type 4X, non-metallic, corrosion resistant, fiberglass reinforced polyester enclosed switches.
- Type 7/9 enclosed switches, for hazardous locations.
- Types 1 and 3R/12, 4-Pole safety switches (see pages DE2-10 and DE2-11).
- Types 3R/12, 6-Pole safety switches (see pages DE2-10 and DE2-11).
- Types 4/4X stainless steel and 3R/12 interlocked receptacle switches, with Crouse-Hinds Arktite® Receptacles (see page DE2-14).
- Types 4/4X stainless steel and 3R/12 interlocked receptacle switches, with Appleton® Receptacles (see page DE2-14).





Arktite® is a Registered Trademark of Crouse-Hinds Company.  
Appleton® is a Registered Trademark of Appleton Electric Limited.

# Safety Switches

## General Duty, Light Duty & Air Conditioning Disconnects

Single Throw  
120/240 Vac, 1-Pole, 2-Pole & 3-Pole

DE2 SAFETY SWITCHES

System	Amps	Type of Fuse	Voltage Vac	Type 1	Type 3R	HP Rating ▽			
						Std.		Max.	
						1Ø	3Ø	1Ø	3Ø
<b>Light Duty Switches</b>									
	30	Plug	120	L111N ▲	---	0.5	---	2	---
<b>General Duty 2-Pole + S/N</b>									
	30	Plug	120/240	CD211N ▲	---	1.5	---	3	---
	30	Cartridge	120/240	CD221N ▲	---	1.5	---	3	---
	60			CD222N	CD222NRB	3	---	10	---
	100			CD223N	CD223NRB	7.5	---	15	---
	200			CD224N *	CD224NRB *	15	---	---	---
	400			CD225N	CD225NR	---	---	---	---
	600			CD226N	CD226NR	---	---	---	---
<b>General Duty 3-Pole + S/N</b>									
	30	Cartridge	120/240	CD321N ▲	CD321NRB ▲	1.5	3	3	7.5
	60			CD322N	CD322NRB	3	7.5	10	15
	100			CD323N	CD323NRB	7.5	15	15	30
	200			CD324N *	CD324NRB *	15	25	---	60
	400			CD325N	CD325NR	---	50	---	125
	600			CD326N	CD326NR	---	75	---	150
<b>Unfused Air Conditioning Disconnect - Moulded Case Switch</b>									
	60	---	240	---	CQO200TR X	---	---	10	---

- Fusible switches are suitable for use as service equipment except where marked ▲.
- ▲ Not suitable for use as service equipment.
- X Does not contain over current protection. Suitable for use on systems with up to 10,000 RMS Symmetrical Amperes available fault current at 240Vac max when protected by a fuse or circuit breaker rated 60A or less.
- Type 3R Switches with "RB" suffix are supplied with main entry hole cut in top endwall and closing cap (BCAP) installed. Hole accepts 3/4 in. to 2 1/2 in. hubs.
- \* For 200% neutral, order (1) additional neutral kit CSN20, and (1) neutral jumper kit SN20NI.
- \* Class J Fuse Provisions:
  - Not available on 30A - 100A General Duty Safety Switches.
  - Available on 200A - 400A General Duty Safety Switches. Field relocation of the load side fuse base assemblies to the alternate Class J fuse position marked in the switch is required.
  - Available on 600A General Duty Safety Switches. Field installation of Class J Fuse Kit GDJK600 is required.

### Application Information

- ▽ HP Ratings:
- Standard - using fast acting one time fuses
  - Maximum - using time delay fuses
- General Duty Switches have Quick-Make / Quick-Break operating mechanisms and Load-Make / Load-Break rated.
  - Light Duty Switches have Slow-Make / Slow-Break operating mechanisms and are Load-Make / Load-Break rated.
  - For information regarding accessories and optional features, see page DE2-30.
  - For more information consult Schneider Electric.

#### Short Circuit Withstand Ratings

Voltage	RMS Symmetrical k Amps				
	Fuse Class				
	Plug	H	K	J	R
240 Vac	10	10	10	100	100

- Class J fuse provisions available on 400 & 600A only, (page DE2-30).

### Approximate Dimensions - Light Duty Type 1

Catalogue Number	Height (H) in./mm	Width (W) in./mm	W/H in./mm	Depth (D) in./mm
L111N	7.63/194	5.00/127	6.13/156	4.00/102

### Approximate Dimensions - General Duty Type 1

Ampere Rating	Height (H) in./mm	Width (W) in./mm	W/H in./mm	Depth (D) in./mm
30	9.25/235	6.75/171	7.25/184	3.63/92
60	14.63/372	6.50/165	7.45/189	4.88/124
100	17.50/445	8.50/216	10.50/267	6.50/165
200	29.00/737	17.25/438	19.00/483	8.25/210
400	45.12/1146	24.00/610	24.88/632	8.88/226
600	49.13/1248	24.00/610	24.88/632	8.88/226

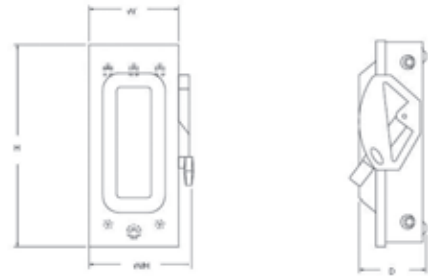

Typical Type 1 Enclosure

### Approximate Dimensions - General Duty Type 3R

Ampere Rating	Height (H) in./mm	Width (W) in./mm	W/H in./mm	Depth (D) in./mm
30	9.63/245	7.25/184	7.75/197	3.75/95
60	14.88/378	6.63/168	7.45/189	4.88/124
100	17.50/445	8.50/216	10.50/267	6.50/165
200	29.25/743	17.25/438	19.00/483	8.25/210
400	30.63/778	21.38/543	22.25/565	10.13/257
600	49.13/1248	24.75/629	25.13/638	8.88/226

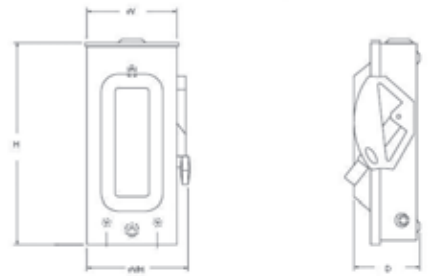

Typical Type 3R Enclosure

### Terminal Lug Data

Ampere Rating	Conductors per Phase	Wire Range AWG/Kcmil
30	1	12 - 6 (Al) or 14 - 6 (Cu)
60	1	12 - 2 (Al) or 14 - 2 (Cu)
100	1	12-1/0 (Al) or 14-1/0 (Cu)
200	1	6 - 300 (Al/Cu)
400▲ Type 1	1 or 2	(1) 1/0-750 (Al/Cu) or (2) 1/0- 300 (Al/Cu)
400 Type 3R	2	(1) 1-600 (Al/Cu) or (2) 1/0-250 (Al/Cu)
600▲	2	4 - 600 (Al/Cu)

▲ Optional wire range: (1) 1/0 - 600 or, (2) 1/0 - 500 or (4) 1/0 - 250 when lug kit GD 4060 LK is used. Kit applicable to Type 1 enclosures only.

■ 30-100 Amp switches suitable for 60° or 75°C conductors. 200-600 Amp switches suitable for 75°C conductors.

### Approximate Dimensions - Air Conditioning Disconnects

	Ampere Rating	Height (H) in./mm	Width (W) in./mm	Depth (D) in./mm	Conductors Per Phase	Wire Range
CQ0200TR	60	6.50/165	4.63/118	3.88/99	1	#14-#4 Al/Cu

# Safety Switches Heavy Duty

Single Throw - Fusible  
240 Vac, 250 Vdc, 2-Pole & 3-Pole

DE2 SAFETY SWITCHES

System	Amps	Fuse Type Provision	Type 1	Type 3R	Type 4/4X Stainless Steel	Type 3R/12	HP Rating ▽			
							240 Vac		250 Vdc	
							Std.		Max.	
						1Ø	3Ø	1Ø	3Ø	

## 2-Pole + S/N



30	H	CH221N	CH221NRB	-	CH221NAWK *	1.5	3	5	
60	H	CH222N	CH222NRB	-	CH222NAWK *	3	10	10	
100	H	CH223N	CH223NRB	-	CH223NAWK *	7.5	15	20	
200	H	CH224N	CH224NRB	-	CH224NAWK *	15	-	40	
400	H	CH225N	CH225NR	-	CH225NAWK	-	-	50	
600	H	CH226N	CH226NR	-	CH226NAWK	-	-	50	
800	L	H227N	H227NR	-	H227NAWK	50	50	50	
1200	L	H228N	H228NR	-	H228NAWK	50	50	50	

## 3-Pole + S/N



						1Ø	3Ø	1Ø	3Ø
30	H	CH321N	CH321NRB	CH321NDS *	CH321NAWK *	1.5	3	3	7.5
60	H	CH322N	CH322NRB	CH322NDS *	CH322NAWK *	3	7.5	10	15
100	H	CH323N	CH323NRB	CH323NDS *	CH323NAWK *	7.5	15	15	30
200	H	CH324N	CH324NRB	CH324NDS *	CH324NAWK *	15	25	-	60
400	H	CH325N	CH325NR	CH325NDS	CH325NAWK	-	50	-	125
600	H	CH326N	CH326NR	CH326NDS	CH326NAWK	-	75	-	200
800	L	H327N	H327NR	-	H327NAWK	50	100	50	250
1200	L	H328N	H328NR	-	H328NAWK	50	100	50	250

- Type 3R switches with "RB" suffix are supplied with main entry hole cut in top endwall and closing cap (BCAP) installed. Hole accepts 3/4 in. to 2 1/2 in. hubs.
- Type 3R switches with "R" suffix have a blank endwall.
- Type 3R/12 switches are suitable for Type 3R application by removing the drainscrew from bottom endwall.
- For switching DC, use any two switching poles.
- Fusible switches 240V are suitable for use as service equipment.
- For installing class J fuses:
  - Relocation of the load side fuse base assembly is required in 100-400 A, 240V switches.
  - Addition of an adapter kit H600J is required in 600A switches.
- 30-600 A 240V switches accept class R fuses as standard. For class R fuse rejection kit information please refer to page DE2-23.

\* Type 3R/12, 4/4X 30-200A are supplied with viewing window standard.

## Application Information

- Dimensions are approximate only. Do not use for construction.

## Application Information

▽ HP Ratings:

- Standard - using fast acting one time fuses
- Maximum - using time delay fuses
- refer to latest design series only
- Heavy Duty Switches have Quick-Make / Quick-Break operating mechanisms Load-Make / Load-Break rated.
- For information regarding accessories and optional features, see pages DE2-23 to DE2-27.
- For more information consult Schneider Electric.

• Short Circuit Current Ratings ♦

Voltage	RMS Symmetrical k Amps			
	Fuse Class			
	H	J	L	R
600 Vac	10	200	200	200

♦ Apply to AC only.

### Approximate Dimensions - Type 1

Ampere Rating	Height (H) in./mm	Width (W) in./mm	W/H in./mm	Depth (D) in./mm
30	14.60/371	6.50/165	7.55/192	4.88/124
60	14.60/371	6.50/165	7.55/192	4.88/124
100	21.25/540	8.50/216	10.50/267	6.38/162
200	29.00/737	17.13/435	18.50/470	8.25/210
400 2-pole	50.25/1276	27.63/702	27.63/702	10.13/257
400 3-pole	50.25/1276	27.88/708	27.88/708	10.13/257
600	50.25/1276	27.63/702	27.63/702	10.13/257
800	69.13/1756	36.62/930	36.63/929	17.75/451
1200	69.13/1756	36.62/930	36.63/929	17.75/451

### Approximate Dimensions - Type 3R

Ampere Rating	Height (H) in./mm	Width (W) in./mm	W/H in./mm	Depth (D) in./mm
30	14.88/378	6.63/168	7.55/192	4.88/124
60	14.88/378	6.63/168	7.55/192	4.88/124
100	21.25/540	8.50/216	10.50/267	6.38/162
200	29.25/743	17.25/438	18.63/473	8.50/216
400	50.31/1278	27.76/705	27.76/705	9.53/257
600	50.31/1278	27.76/705	27.76/705	9.53/257
800	69.13/1756	36.62/930	36.63/929	17.75/451
1200	69.13/1756	36.62/930	36.63/929	17.75/451

### Approximate Dimensions - Type 4/4X

Ampere Rating	Height (H) in./mm	Width (W) in./mm	W/H in./mm	Depth (D) in./mm
30	14.93/379	7.22/183	8.67/220	5.11/130
60	14.93/379	7.22/183	8.67/220	5.11/130
100	20.82/529	9.36/238	11.25/286	6.97/177
200	29.00/737	17.75/451	19.25/489	8.88/226
400	46.25/1175	26.25/667	26.25/667	10.13/259
600	46.25/1175	26.25/667	26.25/667	10.13/259
800	-	-	-	-
1200	-	-	-	-

### Approximate Dimensions - Type 3R/12

Ampere Rating	Height (H) in./mm	Width (W) in./mm	W/H in./mm	Depth (D) in./mm
30	14.60/371	6.63/168	7.55/192	4.96/126
60	14.60/371	6.63/168	7.55/192	4.96/126
100	20.50/521	9.00/229	10.50/267	7.00/178
200	29.00/737	17.25/438	18.63/473	8.75/216
400	46.25/1175	26.25/667	26.25/667	10.13/259
600	46.25/1175	26.25/667	26.25/667	10.13/259
800	69.13/1756	36.63/929	36.63/929	17.75/451
1200	69.13/1756	36.63/929	36.63/929	17.75/451

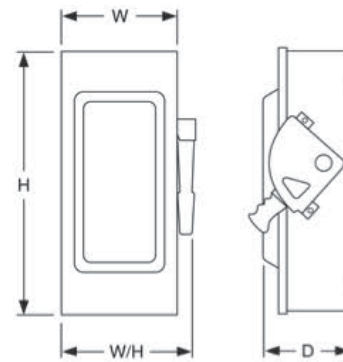

Typical 30-200 A Type 1 Enclosure

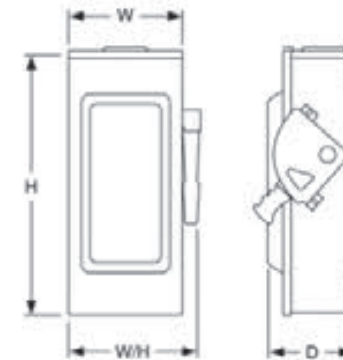

Typical 30-200 A Type 3R Enclosure

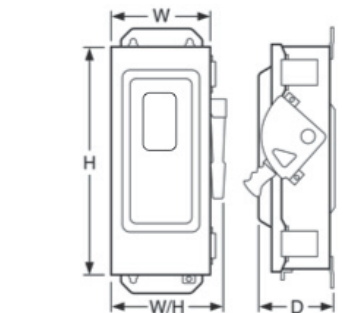

Typical 30-200 A Type 4, 4X, 5, 12 Enclosure  
(Stainless has flat front)

## Application Information

- Dimensions are approximate only. Do not use for construction.
- For terminal lug data refer to page DE2-26.

# Safety Switches Heavy Duty

## Single Throw - Fusible & Non-Fusible 600 Vac, 600 Vdc, 3-Pole

DE2 SAFETY SWITCHES

System	Amps	Fuse Type Provision	Type 1	Type 3R	Type 4/4X Stainless Steel	Type 3R/12	HP Rating ▾							
							240 Vac		480 Vac		600Vac		250 Vdc	600 Vdc
							Std.	Max.	Std.	Max.	Std.	Max.	▼	▼
<b>3-Pole, Fusible</b>														
	30	J	CH361	CH361RB	CH361DS *	CH361AWK *	-	-	5	15	7.5	20	5	15
	60	J	CH362	CH362RB	CH362DS *	CH362AWK *	-	-	15	30	15	50	10	30
	100	J	CH363	CH363RB	CH363DS *	CH363AWK *	-	-	25	60	30	75	20	50
	200	J	CH364	CH364RB	CH364DS *	CH364AWK *	-	-	50	125	60	150	40	50
	400	H	CH365	CH365R	CH365DS	CH365AWK	-	-	100	250	125	350	50	50
	600	H	CH366	CH366R	CH366DS	CH366AWK	-	-	150	400	200	500	50	50
	800	L	H367	H367R	-	H367AWK	-	-	200	500	250	500	50	50
	1200	L	H368	H368R	-	H368AWK	-	-	200	500	250	500	50	50

<b>3-Pole, Non-Fusible</b>														
							10	30	10	30	10	30		
	30	-	CHU361	CHU361RB	CHU361DS *	CHU361AWK *	5	10	7 1/2	20	10	30	5	15
	60	-	CHU362	CHU362RB	CHU362DS *	CHU362AWK *	10	20	25	50	30	60	10	30
	100	-	CHU363	CHU363RB	CHU363DS *	CHU363AWK *	20	40	40	75	40	100	20	50
	200	-	CHU364	CHU364RB	CHU364DS *	CHU364AWK *	15	60	50	125	50	150	40	50
	400	-	CHU365	CHU365R	CHU365DS	CHU365AWK	-	125	-	250	-	350	50	50
	600	-	CHU366	CHU366R	CHU366DS	CHU366AWK	-	200	-	400	-	500	50	50
	800	-	HU367	HU367R	-	HU367AWK	50	250	50	500	50	500	50	50
	1200	-	HU368	HU368R	-	HU368AWK	50	250	50	500	50	500	50	50

- Type 3R switches with "RB" suffix are supplied with main entry hole cut in top endwall and closing cap (BCAP) installed. Hole accepts 3/4 in. to 2 1/2 in. hubs.
- Type 3R switches with "R" suffix have a blank endwall.
- Type 3R/12 switches are suitable for Type 3R application by removing the drainscrew from bottom endwall.
- 30-200 A switches are silicone free devices.
- Fusible switches are suitable for use as service equipment when installed with a neutral kit except 1200A on 480Y/277 or 600Y/347 grounded wye systems, per CEC 215.10 and 230.95.
- Provisions for installing class H, R fuses are included in 30-200 A 600V fusible switches. Relocation of the load side fuse base assembly is required.
- For installing class J fuses:
  - Relocation of the load side fuse base assembly is required in 400A, 600V fusible switches.
  - Addition of an adapter kit H600J is required in 600A, 600V fusible switches.
- ▼ Use outside two poles for switching DC.
- \* Type 3R/12, 4/4X are supplied with viewing window standard.

## Application Information

- ▽ Hp Ratings for fusible switches:
  - Standard - using fast acting one time fuses
  - Maximum - using time delay fuses
  - refer to latest design series only
- Heavy Duty Switches have Quick-Make / Quick-Break operating mechanisms Load-Make / Load-Break rated.
- For information regarding accessories and optional features, see pages DE2-23 to DE2-27.
- For more information consult Schneider Electric.
- ◉ For CSA certified short-circuit current rating for Square D Heavy Duty, Non Fused switches, please refer to page DE2-23.

Voltage	Short Circuit Current Ratings ◉◆			
	RMS Symmetrical k Amps			
	Fuse Class			
	H	J	L	R
600 Vac	10	200	200	200

◆ Apply to AC only.



### Approximate Dimensions - Type 1

Ampere Rating	Height (H) in./mm	Width (W) in./mm	W/H in./mm	Depth (D) in./mm
30	14.60/371	6.50/165	7.55/192	4.88/124
60	17.50/445	9.00/229	10.50/267	6.38/162
100	21.25/540	8.50/216	10.50/267	6.38/162
200	29.00/737	17.13/435	18.50/470	8.25/210
400	50.25/1276	27.63/702	27.63/702	10.13/257
600	50.25/1276	27.63/702	27.63/702	10.13/257
800	69.13/1756	36.62/930	36.62/930	17.75/451
1200	69.13/1756	36.62/930	36.62/930	17.75/451

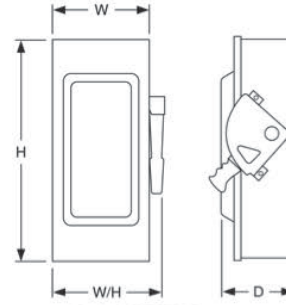

Typical Type 1 Enclosure

### Approximate Dimensions - Type 3R

Ampere Rating	Height (H) in./mm	Width (W) in./mm	W/H in./mm	Depth (D) in./mm
30	14.88/378	6.63/168	7.55/192	4.88/124
60	17.50/445	9.00/229	10.50/267	6.38/162
100	21.25/540	8.50/216	10.50/267	6.38/162
200	29.25/743	17.25/438	18.63/473	8.50/216
400	50.31/1278	27.76/705	27.76/705	9.53/257
600	50.31/1278	27.76/705	27.76/705	9.53/257
800	69.13/1756	36.62/930	36.62/930	17.75/451
1200	69.13/1756	36.62/930	36.62/930	17.75/451

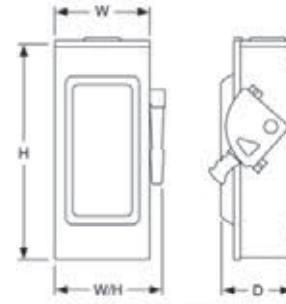

Typical Type 3R Enclosure

### Approximate Dimensions - Type 4/4X

Ampere Rating	Height (H) in./mm	Width (W) in./mm	W/H in./mm	Depth (D) in./mm
30	14.93/379	7.22/183	8.67/220	5.11/130
60	16.87/428	8.92/227	10.81/275	6.97/177
100	20.82/529	9.36/238	11.25/286	6.97/177
200	29.00/737	17.75/451	19.25/489	8.88/226
400	46.25/1175	26.25/667	26.25/667	10.13/259
600	46.25/1175	26.25/667	26.25/667	10.13/259
800	-	-	-	-
1200	-	-	-	-

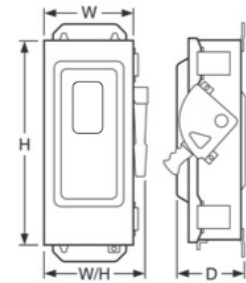

Typical Type 4, 4X, 5, 12 Enclosure  
(Stainless has flat front)

### Approximate Dimensions - Type 3R/12

Ampere Rating	Height (H) in./mm	Width (W) in./mm	W/H in./mm	Depth (D) in./mm
30	14.60/371	6.63/168	7.55/192	4.96/126
60	16.50/419	9.00/229	10.50/267	7.00/178
100	20.50/521	9.00/229	10.50/267	7.00/178
200	29.00/737	17.25/438	18.63/473	8.75/216
400	46.25/1175	26.25/667	26.25/667	10.13/259
600	46.25/1175	26.25/667	26.25/667	10.13/259
800	69.13/1756	36.62/930	36.62/930	17.75/451
1200	69.13/1756	36.62/930	36.62/930	17.75/451





## Application Information

- Dimensions are approximate only. Do not use for construction.
- For terminal lug data refer to page DE2-26.

# Safety Switches Heavy Duty

## Single Throw - Fusible & Non-Fusible 600 Volt, 4 & 6 Pole (Not Suitable for Service Equipment)

DE2 SAFETY SWITCHES

System	Amps	Fuse Type Provision	Type 1	Type 3R	Type 4/4X Stainless Steel	Type 3R/12	HP Rating ▾							
							240 Vac		480 Vac		600 Vac		250 Vdc	600 Vdc
							Std.	Max.	Std.	Max.	Std.	Max.	▼	▼
<b>4-Pole, Fusible</b>														
	30	H	H461	-	H461DS	H461AWK	-	-	7 1/2	20	10	25	5	15
	60	H	H462	-	H462DS	H462AWK	-	-	15	40	20	50	10	30
	100	H	H463	-	H463DS	H463AWK	-	-	25	50	30	75	20	30
	200	H	H464	-	H464DS	H464AWK	-	-	50	-	50	-	40	50
	400	H	CH465 Δ	-	-	CH465AWK Δ	-	-	-	-	-	-	-	-
	600	H	CH466 Δ	-	-	-	-	-	-	-	-	-	-	-
<b>4-Pole, Non-Fusible □</b>														
	30	-	HU461 *	-	HU461DS	HU461AWK	10	10	20	20	25	30	10◆	15◆
	60	-	HU462 *	-	HU462DS	HU462AWK	20	20	40	50	50	60	10	30
	100	-	HU463 *	-	HU463DS	HU463AWK	30	40	50	75	50	75	20	30
	200	-	HU464 *	-	HU464DS	HU464AWK	50	60	50	125	50	150	40	50
	400	-	CHU465 Δ	-	-	CHU465AWK Δ	-	-	-	-	-	-	-	-
	600	-	CHU466 Δ	-	-	CHU466AWK Δ	-	-	-	-	-	-	-	-
<b>6-Pole, Fusible</b>														
	30	-	-	-	-	-	-	-	-	-	-	-	-	-
	60	-	-	-	-	-	-	-	-	-	-	-	-	-
	100	H	-	-	H663DS	H663AWK	-	-	25	60	30	75	-	-
	200	H	-	-	H664DS ▲	H664AWK ▲	-	-	-	-	-	-	-	-
<b>6-Pole, Non-Fusible □</b>														
	30	-	-	-	HU661DS	HU661AWK	-	10	-	20	-	30	-	-
	60	-	-	-	HU662DS	HU662AWK	-	20	-	50	-	60	-	-
	100	-	-	-	HU663DS	HU663AWK	-	40	-	75	-	75	-	-
	200	-	-	-	HU664DS	HU664AWK	-	60	-	125	-	150	-	-

- Type 3R/12 Switches are suitable for type 3R application by removing the drainscrew from bottom endwall.
- 30-200 A switches are silicone free devices.
- Not suitable for use as service equipment.
- ▼ Use outside two poles for switching DC
- ▲ For applications requiring motor disconnect capability, use electrical interlock. Refer to page DE2-25.
- \* No knockouts are provided
- HP rating for Non-Fusible switches are 2Ø & 3Ø (Not Std & Max).
- Δ 600 Vac only
- ◆ HU461AWK (Series E1) is rated 5 HP@250 Vdc, 10HP@600 Vdc.

## Application Information

- ▽ HP Ratings for Fusible Switches:
  - Standard - using fast acting one time fuses
  - Maximum - using time delay fuses
  - refer to latest design series only
- Heavy Duty Switches have Quick-Make / Quick-Break operating mechanisms Load-Make / Load-Break rated.
- For information regarding accessories and optional features, see pages DE2-23 to DE2-27.
- For more information consult Schneider Electric.

○ The CSA certified short-circuit current rating for Square D Heavy Duty, Non Fused switches, please refer to page DE2-23.

### Short Circuit Current Ratings ○◆

Voltage	RMS Symmetrical k Amps			
	Fuse Class			
	H	J	L	R
600 Vac	10	200	200	200

◆ Apply to AC only.

### Approximate Dimensions - 4-Pole, Type 1

Ampere Rating	Height (H) in./mm	Width (W) in./mm	W/H in./mm	Depth (D) in./mm
30	20.50/521	14.75/375	16.13/410	6.85/174
60	20.50/521	14.75/375	16.13/410	6.85/174
100	20.50/521	14.75/375	16.13/410	6.85/174
200	29.00/737	23.25/591	24.88/632	8.75/222
400	50.25/1276	33.88/861	33.88/861	10.13/257
600	50.25/1276	33.88/861	33.88/861	10.13/257

### Approximate Dimensions - 4-Pole, Type 4/4X

Ampere Rating	Height (H) in./mm	Width (W) in./mm	W/H in./mm	Depth (D) in./mm
30	20.82/529	15.08/383	16.85/428	6.85/174
60	20.82/529	15.08/383	16.85/428	6.85/174
100	20.82/529	15.08/383	16.85/428	6.85/174
200	29.00/737	23.75/603	25.25/641	8.88/226

### Approximate Dimensions - 4-Pole, Type 3R/12

Ampere Rating	Height (H) in./mm	Width (W) in./mm	W/H in./mm	Depth (D) in./mm
30*	20.50/521	14.75/375	16.13/410	6.80/173
HU461AWK	16.63/422	9.88/251	11.00/279	6.13/156
60	20.50/521	14.75/375	16.13/410	6.80/173
100	20.50/521	14.75/375	16.13/410	6.80/173
200	29.00/737	23.25/591	24.88/632	8.75/222
400	46.25/1175	32.50/826	32.50/826	10.13/259
600	46.25/1175	32.50/826	32.50/826	10.13/259

### Approximate Dimensions - 6-Pole, Type 4/4X

Ampere Rating	Height (H) in./mm	Width (W) in./mm	W/H in./mm	Depth (D) in./mm
30	20.82/529	15.08/383	16.85/428	6.97/177
60	20.82/529	15.08/383	16.85/428	6.97/177
100	20.82/529	15.08/383	16.85/428	6.97/177
200	29.00/737	23.75/603	25.25/641	8.88/226

### Approximate Dimensions - 6-Pole, Type 3R/12

Ampere Rating	Height (H) in./mm	Width (W) in./mm	W/H in./mm	Depth (D) in./mm
30	20.50/521	14.75/375	16.13/410	6.80/173
60	20.50/521	14.75/375	16.13/410	6.80/173
100	20.50/521	14.75/375	16.13/410	6.80/173
200	29.00/737	23.25/591	24.88/632	8.75/222

\* Except HU461AWK.

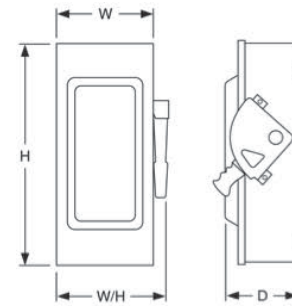

Typical Type 1 Enclosure

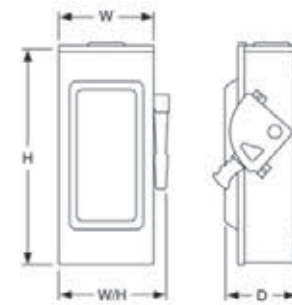

Typical Type 3R Enclosure

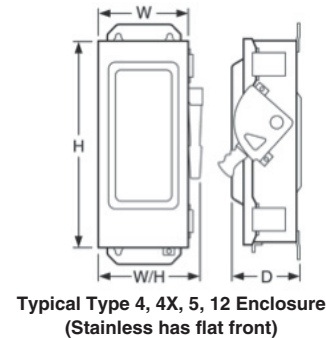

Typical Type 4, 4X, 5, 12 Enclosure  
(Stainless has flat front)

## Application Information

- Dimensions are approximate only. Do not use for construction.
- For terminal lug data refer to page DE2-26.

# Safety Switches



## Heavy Duty, Special Application

### Single Throw 600 Volt, 3-Pole

#### 316 Grade Stainless Steel—Type 3, 3R, 4, 4X, 5, 12



Type 316 stainless steel enclosure safety switches offer superior corrosion resistance to a wider range of chemicals than Type 304 stainless switches. Type 316 resists chloride attacks and is often used in marine, waste treatment and transportation applications. Use watertight hubs from page DE2-26. Equipment ground lugs are supplied as standard. (For Type 304 stainless switches see page DE2-8.) Fusible switches are suitable for use as service equipment when installed with a neutral kit.

#### 3-pole 600 Vac, 600 Vdc

System	Amps	Fuse Type Provision	Catalogue Number	HP Rating 3Ø ▽				
				480 Vac		600 Vac		600 Vdc
				Std.	Max.	Std.	Max.	Max.
<b>Fusible</b>								
	30	H	H361SS	5	15	7.5	20	15
	60	H	H362SS	15	30	15	50	30
	100	H	H363SS	25	60	30	75	50
	200	H	H364SS	50	125	60	150	50
<b>Non-Fusible</b>								
	30	-	HU361SS	-	20	-	30	15
	60	-	HU362SS	-	50	-	60	30
	100	-	HU363SS	-	75	-	100	50
	200	-	HU364SS	-	125	-	150	50

#### Fiberglass Reinforced Polyester Enclosures - Type 4X

Fiberglass Reinforced Polyester enclosures are watertight, corrosion resistant and impervious to windblown dust, rain, and splashing liquid. The moulded fiberglass is extremely stable in a wide range of operating temperatures and can withstand heavy impact. Switches are furnished with hubs and equipment ground lugs. Fusible switches are suitable for use as service equipment when installed with a neutral kit.

System	Amps	Fuse Type Provision	Catalogue Number	HP Rating 3Ø				
				480 Vac		600 Vac		600 Vdc
				Std.	Max.	Std.	Max.	Max.
<b>Fusible</b>								
	30	H	H361DF	5	15	7.5	20	15
	60	H	H362DF	15	30	15	50	30
	100	H	H363DF	25	60	30	75	50
	200	H	H364DF	50	125	60	150	50
<b>Non-Fusible</b>								
	30	-	HU361DF	-	20	-	30	15
	60	-	HU362DF	-	50	-	60	30
	100	-	HU363DF	-	75	-	100	50
	200	-	HU364DF	-	125	-	-	50

#### Type 7/9 Enclosures

An enclosed automatic moulded case switch for use in a Class I, Groups C & D, Division 1 or 2, (Type 7); Class II, Groups E, F, & G, Division 1 or 2, (Type 9); or Class III, Division 1 or 2, (Type 9).

Furnished with threaded conduit openings in both top and bottom endwall

Not suitable for use as service equipment, and listed as "Raintight" for outdoor applications.

3-Pole, Unfused, 600Vac, 250Vdc Maximum, Short Circuit Rating 10 000 AIR.

System	Amps	Catalogue Number	HP Rating 3Ø		
			240 Vac	480 Vac	600 Vac
	60	H60XFA ■*	15	30	50
	100	H100XFA ■*	30	60	75
	225A	H225XJG ■▲	60	125	150

■ Includes PKDB-1, breather and drain kit, required for rain proof application - Type 7 only.  
Electrical Interlocks not available. For auxiliary switches, add 1212 suffix to standard switch catalogue number and price adder (e.g. H60XFA1212)  
Auxiliary Interlocks factory Installed only.

▲ Not CSA certified or UL listed due to wire bending space requirements.  
\* cULus listed.

## Application Information

#### ▽ HP Ratings:

- Standard - using fast acting one time fuses
- Maximum - using time delay fuses
- refer to latest design series only
- Heavy Duty Switches have Quick-Make / Quick-Break operating mechanisms Load-Make / Load-Break rated.
- For information regarding accessories and optional features, see pages DE2-23 to DE2-27.
- For more information consult Schneider Electric.

- The CSA certified short-circuit current rating for Square D Heavy Duty, Non Fused switches is based on the switch being used in conjunction with fuses. Evaluation of not fused switches in conjunction with molded case circuit breakers has not been performed. If a CSA certified short-circuit current rating is required, this not fused switch must be replaced with a SQUARE D Heavy Duty Fusible safety switch equipped with the appropriate class and size fusing. Consult the wiring diagram of the switch to verify the CSA certified short-circuit current rating.

#### • Short Circuit Current Ratings ♦♦

Voltage	RMS Symmetrical k Amps			
	Fuse Class			
	H	J	L	R
600 Vac	10	200	200	200

♦♦ Apply to AC only.

# Safety Switches Heavy Duty, Special Application

Single Throw  
600 Volt, 3-Pole

## Approximate Dimensions - Fiberglass-reinforced Polyester-Type 4X

Ampere Rating	Height (H) in./mm	Width (W) in./mm	W/H in./mm	Depth (D) in./mm
30	16.50/419	11.00/279	11.00/279	8.80/224
60	16.50/419	11.00/279	11.00/279	8.80/224
100	24.80/630	13.70/348	13.70/348	12.00/304
200	31.30/795	26.30/668	26.30/668	11.80/300

## Approximate Dimensions - Type 7/9 Enclosures

Ampere Rating	Height (H) in./mm	Width (W) in./mm	W/H in./mm	Depth (D) in./mm
60	15.93/405	9.87/251	9.87/251	6.96/177
100	15.93/405	9.87/251	9.87/251	6.96/177
200	22.56/573	10.88/277	10.88/277	7.75/197

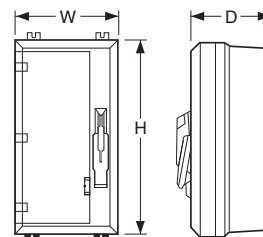

Typical Type 4X  
Fiberglass-reinforced Polyester Enclosure

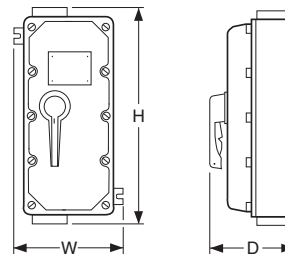

Typical Type 7/9 Enclosure

## Conduit Provisions - Type 4X and Type 7/9

Ampere Rating	Top/Bottom Endwall	
	Type 4X	* Type 7/9
30	3/4"	-
60	1 1/4"	3/4"
100	2"	1 1/4"
200	2 1/2"	2 1/2"

- Hubs and hub drilling templates are provided for field installation (Type 4X).
- \* Threaded conduit opening (Type 7/9).

## Application Information

- Dimensions are approximate only. Do not use for construction.
- For terminal lug data refer to page DE2-26.

# Safety Switches

## Heavy Duty, Special Application

### Motor Disconnect Switches



The MD motor disconnect switch is certified to CSA C22.2 No. 14 Suitable For Motor Control. It is in a compact NEMA 4X enclosure suitable for use in NEMA Type 1, 3, 3R, 4, 4X and 12 applications. The MD's key benefits are an extremely small footprint, a more economically efficient NEMA 4X solution and a handle interlock preventing cover removal when the switch is in the ON position.

#### MD Motor Disconnect Switch—Non Metallic NEMA 1, 3, 3R, 4, 4X and 12 Enclosure ■ ◆

Amperes	Catalogue Number	Maximum Horse Power Ratings			Height (in.)	Width (in.)	Depth (in.)
		Three Phase Vac					
		220-240	440-480	600			
30	MD3304X	7.5	20	25	6.38	3.9	4.37
60	MD3604X	20	40	40	8.27	4.94	4.37

- Complies with OSHA lockout/tagout requirements—accepts up to three 8 mm padlocks.
- ◆ Suitable for NEMA 1, 3R, 4, 4X and 12 enclosure applications.

#### MD Motor Disconnect Accessories

Cat. No.	Description
MDSAN20	2 Normally open auxiliary contact module
MDSAN11	1 normally open and 1 normally closed auxiliary contact module
MDS30P	30 Amp Add on power pole

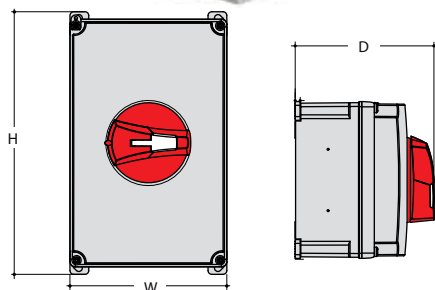

MD Motor Disconnect Switches



- RCD NEMA 3R Switches
- Front Accessible Terminals
  - Foolproof Mechanism Installation
  - Compact Design
  - Flush Backwall
  - 1/2 - 3/4" Knockouts
  - Stainless Steel Hardware

### EEMAC 3R Non-Fused Weatherproof Switches (600V Maximum)

Poles	Amp Rating	Cat. No.	Dimensions – inches (mm)				Max. HP Rating				Replacement Mech Cat. No.
			H	W	D	Height (with handle)	120 VAC	240 VAC	480 VAC	600 VAC	
2	30	RCD5326	8 3/4 (222)	4 1/2 (114)	3 1/4 (83)	9 3/8 (238)	2	5	10	15	
3	30	RCD5336					3	7.5	15	20	
2	60	RCD5626					-	10	15	20	RCD60002FW
3	60	RCD5636					-	10	25	30	RCD60003FW



- The Schneider Electric 30 AMP RCD Safety Switch is a cost effective commercial disconnect, perfect for use in outdoor HVAC (Heating Ventilation and Air Conditioning), Air Handling and Air Compressor applications.
- The RCD line provides a compact, yet easy to work in EEMAC 3R painted steel enclosure.
- Two sets of 1/2-3/4" combination knockouts are provided on the bottom and the back of the switch. The switch mechanism features front accessible terminals for easy installation.
- The RCD can be padlocked in the OFF position and provision only is made for padlocking in the ON position. All exposed hardware is rustproof stainless steel.

# Safety Switches

## Heavy Duty Receptacle Switches



### Single Throw 600 Volt, 3-Pole

#### Receptacle Switches with Appleton Receptacles▲ 3-Pole

System	Amps	Fuse Type Provision	Type 3R/12	Type 4/4X (Stainless Steel)	Use with Appleton Plug	HP Ratings - 3Ø ▽					
						480 Vac		600 Vac		250 Vdc	
						Std.	Max.	Std.	Max.	Std.	Max.
<b>Fusible</b>											
	30	H	H361AWAVW *	H361DSWAVW *	ACP3034BC	5	15	7 1/2	20	5	-
	60	H	H362AWAVW *	H362DSWAVW *	ACP6034BC	15	30	15	50	10	-
	100	H	H363AWAVW *	H363DSWAVW *	ACP1034CD	25	60	30	75	20	-
<b>Non-Fusible</b>											
	30	-	HU361AWAVW *	HU361DSWAVW *	ACP3034BC	-	20	-	30	-	5
	60	-	HU362AWAVW *	HU362DSWAVW *	ACP6034BC	-	50	-	60	-	10
	100	-	HU363AWAVW *	HU363DSWAVW *	ACP1034CD	-	75	-	100	-	20

▲ Classified for use with Crouse-Hinds Arktite® plugs

#### Receptacle Switches with Crouse-Hinds Receptacles 3-Pole

System	Amps	Fuse Type Provision	Type 3R/12	Type 4/4X (Stainless Steel)	Use with Crouse-Hinds Plug	HP Rating - 3Ø ▽			
						480 Vac		600 Vac	
						Std.	Max.	Std.	Max.
<b>Fusible</b>									
	30	J	CH361AWC *	CH361DSWC *	APJ3485	5	15	7 1/2	20
	60	J	CH362AWC *	CH362DSWC *	APJ6485	15	30	15	50
	100	J	CH363AWC *	CH363DSWC *	APJ10487	-	60	-	75
<b>Non-Fusible</b>									
	30	-	CHU361AWC *	CHU361DSWC *	APJ3485	-	20	-	30
	60	-	CHU362AWC *	CHU362DSWC *	APJ6485	-	50	-	60
	100	-	CHU363AWC *	CHU363DSWC *	APJ10487	-	60	-	75

- Type 3R/12 switches are suitable for Type 3R application by removing the drainscrew from bottom endwall.
- Interlocking linkage between receptacle and switch mechanism prevents the insertion or removal of the plug while the switch is in the "ON" position, or the insertion of a plug other than specified. Interlocking linkage also prevents the switch from being thrown into the "ON" position while the plug is removed.
- Fusible switches are suitable for use as service equipment.
- \* Type 3R/12, 4/4X are supplied with viewing window standard.



# Safety Switches Heavy Duty Receptacle Switches

Single Throw  
600 Volt, 3-Pole

## Appleton and Crouse-Hinds Receptacle Switch 600Vac Short Circuit Current Rating

Amperes	10kAIR Fuses	100kAIR Fuses	200kAIR Fuses	14kAIR Circuit Breaker	18kAIR Circuit Breaker
<b>Fusible</b>					
30	H, K	–	J, R	–	–
60	H, K	–	J, R	–	–
100	H, K	–	J, R	–	–
<b>Non-Fusible</b>					
30	H, K	J, R, T*	J, R, T	FA	FH
60	H, K	–	J, R, T	FA	FH
100	H, K	–	J, R, T	FA	FH

\* SCCR when using 60A Max Fuse

### Approximate Dimensions - Appleton Type 3R/12

Ampere Rating	Height (H) in./mm	Width (W) in./mm	W/H in./mm	Depth (D) in./mm	H/R in./mm
30	16.50/419	9.00/229	10.50/267	7.00/178	22.25/565
60	16.50/419	9.00/229	10.50/267	7.00/178	22.25/565
100	20.50/521	9.00/229	10.50/267	7.00/178	26.25/667

### Approximate Dimensions - Appleton Type 4/4X (Stainless Steel)

Ampere Rating	Height (H) in./mm	Width (W) in./mm	W/H in./mm	Depth (D) in./mm	H/R in./mm
30	16.87/428	8.92/227	10.81/275	5.11/130	23.00/584
60	16.87/428	8.92/227	10.81/275	5.11/130	23.00/584
100	20.82/529	9.36/238	11.25/286	6.97/177	28.00/711

### Approximate Dimensions - Crouse-Hinds Type 3R/12

Ampere Rating	Height (H) in./mm	Width (W) in./mm	W/H in./mm	Depth (D) in./mm	H/R in./mm
30	16.50/419	9.00/229	10.50/267	7.00/178	23.25/591
60	16.50/419	9.00/229	10.50/267	7.00/178	23.25/591
100	20.50/521	9.00/229	10.50/267	7.00/178	28.05/712

### Approximate Dimensions - Crouse-Hinds Type 4/4X (Stainless Steel)

Ampere Rating	Height (H) in./mm	Width (W) in./mm	W/H in./mm	Depth (D) in./mm	H/R in./mm
30	16.87/428	8.92/227	10.81/275	5.11/130	23.00/584
60	16.87/428	8.92/227	10.81/275	5.11/130	23.00/584
100	20.82/529	9.36/238	11.25/286	6.97/177	28.00/711

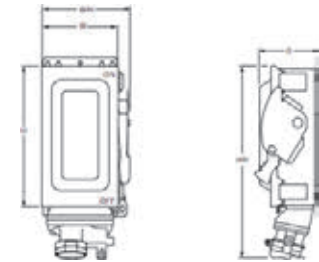

Appleton Receptacle

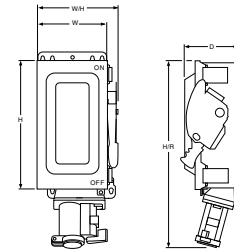

Crouse-Hinds Receptacle

## Application Information

- Dimensions are approximate only. Do not use for construction.
- For terminal lug data refer to page DE2-25.
- ▽ HP Ratings:
  - Standard - using fast acting one time fuses
  - Maximum - using time delay fuses
  - refer to latest design series only
- Heavy Duty Switches have Quick-Make / Quick-Break operating mechanisms Load-Make / Load-Break rated.
- For information regarding accessories and optional features, see pages DE2-23 to DE2-27.

- For more information consult Schneider Electric.
- The CSA certified short-circuit current rating for Square D Heavy Duty, Non Fused switches is based on the switch being used in conjunction with fuses. Evaluation of not fused switches in conjunction with molded case circuit breakers has not been performed. If a CSA certified short-circuit current rating is required, this not fused switch must be replaced with a SQUARE D Heavy Duty Fusible safety switch equipped with the appropriate class and size fusing. Consult the wiring diagram of the switch to verify the CSA certified short-circuit current rating.

- Short Circuit Current Ratings ⚡

Voltage	RMS Symmetrical k Amps			
	Fuse Class			
	H	J	L	R
600 Vac	10	200	200	200

⚡ Apply to AC only.

# Safety Switches Heavy Duty

## 1000 Vdc Photovoltaic Disconnect Switch



Put over 100 years of Schneider Electric's experience as a global specialist in energy management to work on your photovoltaic (PV) project. The Square D 1000 Vdc disconnect switch is the perfect solution for your 1000 Vdc PV disconnect applications. It is compact and available in both a 100 and 200 amp non-fusible versions. UL98-B, IEC 60947-1 and 3 certified (file 136861).

### Extended Life Expectancy

Exceeds IEC 60947-3 mechanical endurance requirements by factor of 18  
Exceeds IEC 60947-1 electrical endurance requirements by factor of 10  
Exceeds NEMA KS-1 mechanical endurance requirements by factor of 3.

### Easy to Install

Preconfigured solar solution  
Familiar enclosed safety switch design  
Suitable for both grounded and ungrounded PV

### Designed for Harsh PV Environments

NEMA Type 3 and IP63 enclosure

- Resists windblown dirt/dust
- Exceeds NEMA Type 1, 3R and 12

Operating range of -37°C to 50°C  
Specially designed PV paint reduces solar gain by 40% over standard grey enclosures

## 1000 Vdc Photovoltaic Heavy Duty Disconnect Switch and Accessories

System	NEMA 1, 3R, 12, 3 and IP63		Factory Installed Accessories					
	Amp	Cat. No.	Electrical Interlock Single Contact▲	Electrical Interlock Two Contacts■	Viewing Windows	Terminal Blocks (Copper)◆	Surge Arrestor Connector★	3 Wire Ground Lug▼
			No. Suffix	No. Suffix	No. Suffix	No. Suffix	No. Suffix	No. Suffix
<b>3 Pole Grounded△</b>								
<b>Three-Pole (Grounded System)</b> 	100	REHU393IP	EI1	EI2	VW	TBC	SA	GL
	200	REHU394IP	EI1	EI2	VW	TBC	SA	GL
<b>4 Pole Ungrounded</b>								
<b>Four-Pole (Ungrounded System)</b> 	100	REHU493IP	EI1	EI2	VW	—	SA	GL
	200	REHU494IP	EI1	EI2	VW	—	SA	GL

- ▲ Order EIK1PV for single contact field-installed kit.
- Order EIK2PV for double contact field-installed kit.
- ◆ Accommodates (2) 250 max Cu or (1) 1/0 max Cu wiring; Order SN20CPV for field-installed kit.
- ★ Required when adding surge arrestors. Accommodates (2) 6-300 Cu/Al wiring; One lug for the line connection and one for the surge arrestor connection.

- ▼ Order AL20DTF for field installable kit.
- ▼ Order REHGND KIT for field installable kit.
- △ Terminal blocks standard with 3 pole switches; accommodates (2) 1/0 max Al/Cu or (2) 6 max Al/Cu wiring.

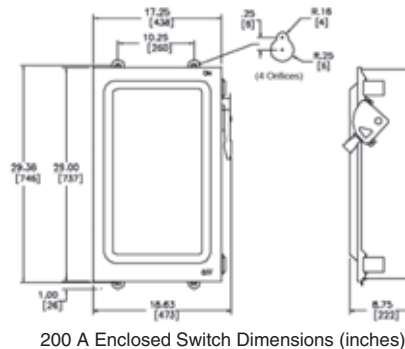
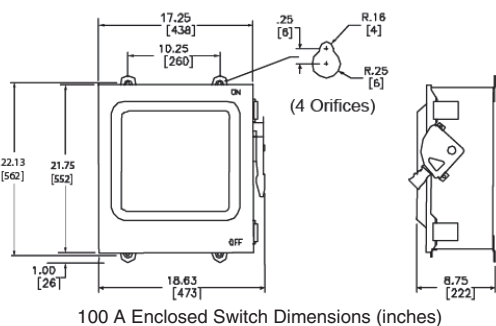

# Safety Switches Double Throw

## Double Throw - Fusible & Non-Fusible 240Vac, 2-Pole & 3-Pole

System	Amps	Ser.	Type 1	Ser.	Type 3R	Ser.	Type 4/4X Stainless Steel	Ser.	Type 3R/12	Horsepower Ratings ▾				250 Vdc ◆
										240 Vac				
										Std.	Std.	Max.	Max.	
										1Ø	3Ø	1Ø	3Ø	

### 2-Pole, Fusible, 240Vac - 250Vdc

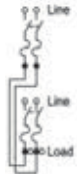

30	-	-	-	-	-	-	-	-	-	-	-	-	-	-
60	-	-	-	-	-	-	-	-	-	-	-	-	-	-
100	F	DT223	F	DT223RB	-	-	-	-	-	7.5	15	15	30	20

### 2-Pole, Non-Fusible, 240Vac



30	T4	C92251 ▲	-	-	-	-	-	-	-	-	-	-	-	-
200	USE 3- POLE 600V DEVICES													
400	A	82255	A	82255R	-	-	A	H82255	-	-	-	-	-	-

### 2-Pole, Non-Fusible, 240Vac - 250Vdc



60	F	DTU222	-	-	-	-	-	-	-	-	-	10	-	10 ▼
100	F	DTU223	F	DTU223RB	-	-	-	-	-	-	-	15	-	20 ▼

### 3-Pole, Fusible, 240Vac - 250Vdc

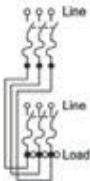

30	F	DT321	F	DT321RB	-	-	-	-	-	1.5 ★	3	3 ★	7.5	5
60	F	DT322	F	DT322RB	-	-	-	-	-	3 ★	7.5	10 ★	15	10
100	F	DT323	F	DT323RB	-	-	-	-	-	7.5 ★	15	15 ★	30	20

### 3-Pole, Non-Fusible, 240Vac - 250Vdc



30	T4	C92351 ▲	-	-	-	-	-	-	-	-	-	-	-	-
200	USE 3- POLE 600V DEVICES													
400	A	82355	A	82355R	-	-	A	H82355	-	-	-	-	-	-
600	A	DTU326	A	DTU326R	-	-	-	-	-	-	125	-	-	50

### 3-Pole, Non-Fusible, 240Vac - 250Vdc



30	F	DTU321	-	-	-	-	-	-	-	-	3	5 ★	10	5 ▼
60	F	DTU322	-	-	-	-	-	-	-	-	-	10 ★	15	10 ▼
100	F	DTU323	F	DTU323RB	-	-	-	-	-	-	-	15 ★	30	20 ▼

- ◆ For switching dc, use outside two poles.
- ★ Use outer switching poles.
- ▼ Maximum rating.
- ▲ Not available with padlock on provision.
- 240 Vac only.

## Application Information

- For application information, see page DE2-19.

# Safety Switches

## Double Throw

### Double Throw - Fusible & Non-Fusible 600 Volt, 2-Pole & 3-Pole

DE2 SAFETY SWITCHES

Horsepower Ratings ▾

System	Amps	Ser.	Type 1	Ser.	Type 3R	Ser.	Type 4/4X Stainless Steel	Ser.	Type 3R/12	Horsepower Ratings ▾							
										240 Vac		480 Vac		600 Vac		DC◆	
										Std.	Max.	Std.	Max.	Std.	Max.	250	600
										3Ø	3Ø	3Ø	3Ø	3Ø	3Ø		

#### 2-Pole, Fusible, 600 Vac

30 - 200A

USE 3 WIRE DEVICES FOR 2 POLE APPLICATION

#### 2-Pole, Non-Fusible, 600 Vac



30 - 600A

USE 3 WIRE DEVICES FOR 2 POLE APPLICATION

#### 3-Pole, Fusible, 600 Vac - 600 Vdc

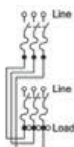

30	F	DT361	F	DT361RB	-	-	-	-	-	-	5	15	7.5	20	5	15
60	F	DT362	F	DT362RB	-	-	-	-	-	-	15	30	15	50	-	30
100	F	DT363	F	DT363RB	-	-	-	-	-	-	25	60	30	75	-	50

#### 3-Pole, Non-Fusible, 600 Vac - 600 Vdc

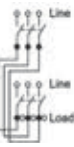

										1Ø	3Ø	1Ø	3Ø	1Ø	3Ø		
30	F	DTU361	F	DTU361RB	-	-	-	-	-	5	10	7.5	20	10	30	5	15
60	F	DTU362	F	DTU362RB	F	DTU362DS	F	DTU362AWK	10	20	25	50	30	60◇	10	30	
100	F	DTU363	F	DTU363RB	F	DTU363DS	F	DTU363AWK	20	40☆	40	75☆	40	75☆	20	50	

#### 3-Pole, Non-Fusible, 600 Vac - 250 Vdc



200	E	C82344 ▲	E	C82344RB ▲	E	C82344DS ▲	E	CH82344 ▲★	-	-	-	-	-	-	-	-
400	A	82345	A	82345R	A	82345DS	A	H82345	-	-	-	-	-	-	-	-
600	A	DTU366	A	DTU366R	-	-	A	DTU366AWK★	-	125	-	250	-	350	50	-

- ◆ For switching dc, use two poles.
- ▼ Use outer switching poles.
- ◇ Use 75° C #4 Cu or #2 Al conductors only.
- ☆ Use 75° C #1 Cu conductors only.
- ★ Type 12 only.
- ▲ For isolation use only.

- Fusible switches accept class H fuses as standard.
- Fusible switches are suitable for use as service equipment when installed with a neutral kit.

### Application Information

- DT & DTU (series F, A), 82,000 Switches have Quick-Make / Quick-Break mechanisms, Load-Make / Load-Break rated.
- 92,000 Lines of Double Throw Switches are not Load-Make / Load-Break rated, for isolation use only.
- For information regarding accessories and optional features, see page DE2-27.
- ▽ HP Rating: Standard value when using fast acting one time fuses. Max. value when using dual element time delay fuse.
- For more information, consult Schneider Electric.

Switch Type	Ampere Rating	Voltage Rating	RMS Symmetrical k Amps ◆			
			Fuse Class			
			H	K	R	J
Type DT Series F	30-100A	240V or 600V	10	10	200	200
Type DTU Series F ★	30-100A	240V or 600V	10	10	200	200
Type DTU Series A	600A	240V or 600V	10	10	100	100
Type 82000	200-400A	240V 600V	10 10	10 10	100 -	100 -
Type 92000	30A	240V	10	10	-	-



◆ Rating applies to AC only. Short circuit current rating for Non-Fusible switches is based on the switch being used in conjunction with the corresponding fuse type. Evaluation of Non-Fusible switches in conjunction with molded case circuit breakers has not been performed.

\* The DTU361 and DTU361RB are also suitable for use on a circuit capable of delivering not more than:  
(A) 18,000 rms symmetrical A, 600 Vac

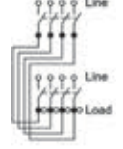

# Safety Switches Double Throw

## Double Throw - Non-Fusible 240 Volt & 600 Volt, 4 & 6 Pole (Not Suitable for Service Equipment)

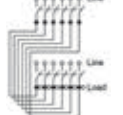
System	Amps	Ser.	Type 1	Ser.	Type 3R	Ser.	Type 4/4X	Ser.	Type 3R/12	Horsepower Ratings ▾													
										Stainless Steel						240 Vac		480 Vac		600 Vac		DC	
										Std.	Max.	Std.	Max.	Std.	Max.	Std.	Max.	Std.	Max.	250	600		
										3Ø	3Ø	3Ø	3Ø	3Ø	3Ø	3Ø	3Ø	3Ø	3Ø				
<b>4-Pole, Non-Fusible, 240 Vac - 250Vdc</b>																							
	30	T4	C92451	Ⓞ	-	-	-	-	-	-	-	-	-	-	-	-							
	60																						
	100																						
	200	E	82454	E	82454R	-	-	-	-	-	-	-	-	-	-	-							
	400	A	82455	Ⓞ	A	82455R	Ⓞ	-	-	A	H82455	Ⓞ	-	-	-	-							
	600	A	DTU426	A	DTU426R	-	-	-	-	-	-	-	125	-	250	-	350	-	50	-			
<b>4-Pole, Non-Fusible, 600 Vac - 600 Vdc</b>																							
													2Ø	3Ø	2Ø	3Ø	2Ø	3Ø					
	30	-	-	-	-	-	-	-	-	-	-	-	-	-	-	-	-	-	-	-			
	60	F	DTU462	F	DTU462AWK	F	DTU462DS	F	DTU462AWK	-	-	-	20	20	40	50	50	60	10	30			
	100	F	DTU463	F	DTU463AWK	F	DTU463DS	F	DTU463AWK	-	-	-	30	40	50	75	50	75	20	30			
<b>4-Pole, Non-Fusible, 600 Vac - 250Vdc</b>																							
	200	E	82444	E	82444R	E	82444DS	-	-	-	-	-	-	-	-	-	-	-	-				
	400	A	82445	A	82445R	-	-	A	H82445	-	-	-	-	-	-	-	-	-	-				
	600	A	DTU466	A	DTU466R	-	-	-	-	-	-	-	125	-	250	-	350	-	50	-			
<b>6-Pole, Non-Fusible, 600 Vac - 600 Vdc</b>																							
													1Ø	3Ø	1Ø	3Ø	1Ø	3Ø					
	30	-	-	-	-	-	-	-	-	-	-	-	-	-	-	-	-	-	-	-			
	60	-	-	-	-	-	-	F	DTU662AWK	-	-	-	-	20	-	50	-	60	10	30			
	100	-	-	-	-	-	-	F	DTU663AWK	-	-	-	-	40	-	75	-	75	20	50			

Ⓞ - 240 Vac only

### Application Information

- For application information, see page DE2-19.

# Safety Switches Double Throw

## Technical Data Approximate Dimensions

DE2 SAFETY SWITCHES

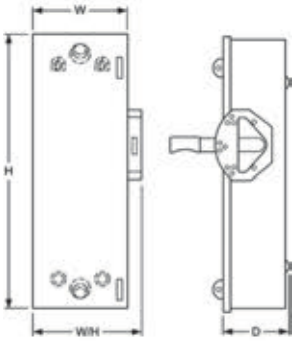

DT, DTU Series F  
Type 1 Enclosure



DT, DTU Series F  
Type 3R Enclosure

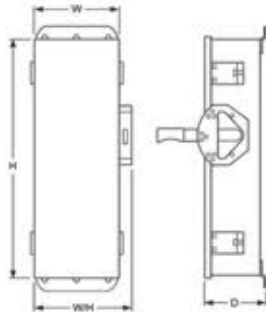

DT, DTU Series F  
Type 4, 4X, 5 and 12 Enclosure

### 30-100 A Type DT, DTU (Series F)—Approximate Dimensions

Catalogue Number	Series	H		W		W/H		D	
		IN	mm	IN	mm	IN	mm	IN	mm
DT321	F5	38.42	976	10.25	260	11.96	304	6.93	176
DT361	F5	38.42	976	10.25	260	11.96	304	6.93	176
DT322	F5	38.42	976	10.25	260	11.96	304	6.93	176
DT362	F5	38.42	976	10.25	260	11.96	304	6.93	176
DT321RB	F5	38.64	982	10.25	260	11.96	304	6.93	176
DT361RB	F5	38.64	982	10.25	260	11.96	304	6.93	176
DT322RB	F5	38.64	982	10.25	260	11.96	304	6.93	176
DT362RB	F5	38.64	982	10.25	260	11.96	304	6.93	176
DT223	F5	38.42	976	10.25	260	11.96	304	6.93	176
DT323	F5	38.42	976	10.25	260	11.96	304	6.93	176
DT363	F5	38.42	976	10.25	260	11.96	304	6.93	176
DT223RB	F5	38.64	982	10.25	260	11.96	304	6.93	176
DT323RB	F5	38.64	982	10.25	260	11.96	304	6.93	176
DT363RB	F5	38.64	982	10.25	260	11.96	304	6.93	176
DTU321	F5	29.94	760	10.25	260	11.96	304	6.93	176
DTU361	F5	29.94	760	10.25	260	11.96	304	6.93	176
DTU222	F5	29.94	760	10.25	260	11.96	304	6.93	176
DTU322	F5	29.94	760	10.25	260	11.96	304	6.93	176
DTU362	F5	29.94	760	10.25	260	11.96	304	6.93	176
DTU223	F5	29.94	760	10.25	260	11.96	304	6.93	176
DTU323	F5	29.94	760	10.25	260	11.96	304	6.93	176
DTU363	F5	29.94	760	10.25	260	11.96	304	6.93	176
DTU361RB	F5	30.50	775	10.25	260	11.96	304	6.93	176
DTU362RB	F5	30.50	775	10.25	260	11.96	304	6.93	176
DTU223RB	F5	30.50	775	10.25	260	11.96	304	6.93	176
DTU323RB	F5	30.50	775	10.25	260	11.96	304	6.93	176
DTU363RB	F5	30.50	775	10.25	260	11.96	304	6.93	176
DTU362AWK	F6	30.26	769	10.25	260	11.96	304	7.18	182
DTU363AWK	F6	30.26	769	10.25	260	11.96	304	7.18	182
DTU362DS	F6	30.30	770	10.25	260	11.96	304	7.18	182
DTU363DS	F6	30.30	770	10.25	260	11.96	304	7.18	182
DTU462	F5	30.30	770	15.46	393	17.18	436	7.18	182
DTU463	F5	30.30	770	15.46	393	17.18	436	7.18	182
DTU462AWK	F6	30.30	770	15.46	393	17.18	436	7.18	182
DTU662AWK	F6	30.30	770	15.46	393	17.18	436	7.18	182
DTU463AWK	F6	30.30	770	15.46	393	17.18	436	7.18	182
DTU663AWK	F6	30.30	770	15.46	393	17.18	436	7.18	182
DTU462DS	F6	30.30	770	15.46	393	17.18	436	7.18	182
DTU463DS	F6	30.30	770	15.46	393	17.18	436	7.18	182

### 30 A Type C92,000 — Approximate Dimensions

Catalogue Number	Series	H		W		W/H		D	
		IN	mm	IN	mm	IN	mm	IN	mm
C92251	T4	11.38	289	10.13	257	13.50	343	6.13	156
C92351	T4	11.38	289	10.13	257	13.50	343	6.13	156
C92451	T4	11.38	289	10.13	257	13.50	343	6.13	156

### 200 A 3P Type C82,000 — Approximate Dimensions

Catalogue Number	Series	H		W		W/H		D	
		IN	mm	IN	mm	IN	mm	IN	mm
C82344	E1	30.88	784	20.00	508	23.88	607	11.75	298
C82344RB	E1	30.88	784	20.00	508	23.88	607	11.75	298
C82344DS	E1	32.90	836	19.90	505	22.90	582	10.30	262
CH82344	E1	32.90	836	19.90	505	22.90	582	10.30	262

### 200 A 4P Type 82,000 — Approximate Dimensions

Catalogue Number	Series	H		W		W/H		D	
		IN	mm	IN	mm	IN	mm	IN	mm
82454	E3	38.00	965	29.62	752	33.02	839	10.63	270
82454R	E3	38.00	965	29.62	752	33.02	839	10.63	270
82444	E3	38.00	965	29.62	752	33.02	839	10.63	270
82444R	E3	38.00	965	29.62	752	33.02	839	10.63	270

### 600 A Type DTU (Series A01) — Approximate Dimensions

Catalogue Number	Series	H		W		W/H		D	
		IN	mm	IN	mm	IN	mm	IN	mm
DTU326	A1	63.31	1608.07	23.66	600.96	24.46	621.28	8.88	225.55
DTU326R	A1	63.76	1619.50	23.66	600.96	24.46	621.28	8.88	225.55
DTU426	A1	63.31	1608.07	27.00	685.80	27.80	706.12	8.88	225.55
DTU426R	A1	63.76	1619.50	27.00	685.80	27.80	706.12	8.88	225.55
DTU366	A1	63.31	1608.07	23.66	600.96	24.46	621.28	8.88	225.55
DTU366AWK	A1	63.76	1619.50	23.66	600.96	24.46	621.28	8.88	225.55
DTU366R	A1	63.76	1619.50	23.66	600.96	24.46	621.28	8.88	225.55
DTU466	A1	63.31	1608.07	27.00	685.80	27.80	706.12	8.88	225.55
DTU466R	A1	63.76	1619.50	27.00	685.80	27.80	706.12	8.88	225.55

### 400 A Type 82,000 (Series A01) — Approx. Dimensions

Catalogue Number	Series	H		W		W/H		D	
		IN	mm	IN	mm	IN	mm	IN	mm
82255	A1	38.50	977.90	26.10	662.94	29.51	749.55	10.63	270.00
82255R	A1	39.00	990.60	26.62	676.15	30.02	762.51	10.63	270.00
82345	A1	38.50	977.90	26.10	662.94	29.51	749.55	10.63	270.00
82345DS	A1	39.00	990.60	26.62	676.15	30.02	762.51	10.63	270.00
82345R	A1	39.00	990.60	26.62	676.15	30.02	762.51	10.63	270.00
82355	A1	38.50	977.90	26.10	662.94	29.51	749.55	10.63	270.00
82355R	A1	39.00	990.60	26.62	676.15	30.02	762.51	10.63	270.00
82445	A1	38.50	977.90	30.10	764.54	33.50	850.90	10.63	270.00
82445R	A1	39.00	990.60	30.21	767.33	33.61	853.69	10.63	270.00
82455	A1	38.50	977.90	30.10	764.54	33.50	850.90	10.63	270.00
82455R	A1	39.00	990.60	30.21	767.33	33.61	853.69	10.63	270.00
H82255	A1	39.00	990.60	26.62	676.15	30.02	762.51	10.63	270.00
H82345	A1	39.00	990.60	26.62	676.15	30.02	762.51	10.63	270.00
H82355	A1	39.00	990.60	26.62	676.15	30.02	762.51	10.63	270.00
H82445	A1	39.00	990.60	30.21	767.33	33.61	853.69	10.63	270.00
H82455	A1	39.00	990.60	30.21	767.33	33.61	853.69	10.63	270.00

### Fuse Provisions

#### Class H Fuse Provisions:

Fusible 30 - 600A Heavy Duty Safety Switches accept Class H fuses as standard except where noted below.

Heavy Duty Safety Switches	30A	60A	100A	200A	400A	600A
2-3-Pole, 240V	H	H	H	H	H	H
3-Pole, 600V	J*	J*	J*	J*	H	H
4-Pole, 600V	H	H	H	H	H	H
6-Pole, 600V	---	---	H	H	---	---
316 Grade Stainless steel	H	H	H	H	---	---
Polyester Enclosures	H	H	H	H	---	---
c/w Appleton Receptacles	H	H	H	---	---	---
c/w Crouse-Hinds Receptacles	J*	J*	J*	---	---	---
MD50 Motor Disconnect	J	J	---	---	---	---
Double Throw	H	H	H	---	---	---

\*Provisions for installing Class H fuses are included in switches supplied with Class J fuses as standard.

Conversion to Class H fuse spacing requires relocating the load side fuse base assembly from the standard J fuse location to an alternate position as marked in the enclosure. With Class H fuses installed, the switch is CSA Certified for use on systems with up to 10,000 RMS Symmetrical Amperes available fault current.

#### Class J Fuse Provisions:

Fusible Square D 30 through 200 Ampere, 600 Volt, 3-Pole Heavy Duty Safety Switches accept Class J fuses as standard\*\*. Provisions for installing Class J fuses are included in 400 Ampere 600 Volt, and 100 through 400 Ampere 240 Volt, fusible, Heavy Duty Safety Switches. Conversion to Class J fuse spacing requires relocating the load side fuse base assembly from the standard H fuse location to an alternate position as marked in the enclosure. With J fuses installed, the switch is CSA Certified for use on systems with up to 200,000 RMS Symmetrical Amperes available fault current. Switches rated 600 Ampere, 240V or 600V, require the addition of an adapter kit, H600J. One kit per 3-pole switch.

\*\* Including switches with Crouse Hinds Receptacles.

#### Class L Fuse Provisions:

Fusible 800A and 1200A Heavy Duty Safety Switches use Class L bolt-on fuses and are CSA Certified for use on systems with up to 200,000 RMS Symmetrical Amperes at 600Vac maximum.

#### English Electric Fuse Provisions (HRCII-C):

English Electric Fuse Provisions are available factory installed only on E-Series and F-Series Safety Switches. Available for all 30 - 200 A, 600V, 3-Pole Safety Switches. HRCII-C Fuse kits are CSA Certified.

To order, add "HE" suffix to standard catalogue number.

Example: CH361HE

#### Fuse Puller Kits

Kit consists of three fuse pullers and can be installed in all E-Series and F-Series Safety Switches, 30 - 100A. Fuse pullers supplied as standard equipment on Type 3R/12, Type 4/4X stainless steel, Type 4X Fiberglass-reinforced Polyester switches through 100 Ampere. Fuse Puller Kits are CSA Certified, and available for factory or field installation.

For factory installation, add "FP" suffix to standard catalogue number.

Example: CH361FP

Switch Ampere Rating	Series Number	Fuse Puller Kit Catalogue Number
30	F5-F7	FPK03Δ
60	F5-F6 (600 V)	FPK0610
60	F5 (240 V)	FPK03
100	F5-F7	FPK0610

Δ 30A, 4- and 6-pole, Series F5 use FPK0610.

#### Class R Fuse Provisions:

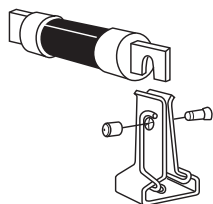

The rejection kit, when installed, rejects all but Class R fuses. With the installation of the rejection kit and Class R fuses, the switch is CSA Certified for use on systems with up to 200,000 RMS Symmetrical Amperes available fault current.

CSA Certified Rejection kits are available for E-Series and F-Series Safety Switches. Kits are available for factory or field installation.

For factory installation, add "CLR" suffix to standard catalogue number.

Example: CH361CLR

### Application Information

• For more information, consult Schneider Electric.

#### Class R Fuse Kits - 240 Volt (one kit per 3-pole switch)

Switch Ampere Rating	Series Number	Class R Fuse Kit Catalogue Number
30	F5-F6	RFK03L
60	F5-F6	RFK03H
100	F5-F6	RFK10
200	F5-F6	HRK1020
400-600	E4-E5	HRK4060

#### Class R Fuse Kits - 600 Volts (one kit per 3-pole switch)

Switch Ampere Rating	Series Number	Class R Fuse Kit Catalogue Number
30	F5-F6	RFK03H *
30 A Receptacle Switches	F7	RFK06
30 A 4 Pole Switches	F5-F6	RFK06
60	F5-F7	RFK06H
100	F5-F7	RFK10
200	F5-F6	HRK1020
400-600	E4-E5	HRK4060

\* The following series F5-F6 devices use RFK06: H461, H461DS, H461AWK, H361DF, H361AWAVW and CH361AWC.

Note: For series not shown in the table, refer to the switch wiring diagram.

#### CSA Certified Maximum Short Circuit Current Ratings—AC only

NOTE: Consult the wiring diagram of the switch to verify the CSA certified short circuit current rating.

#### Fusible Safety Switches

For the short circuit current rating, refer to the table below.

Heavy Duty Safety Switch Type	Fuse Class	Short Circuit Current Ratings
Fusible	H, K	10 kA
	R, J, L	200 kA◆

◆ On 600 V, 200 A switches, 100,000 A max. on corner grounded delta when protected by Class J or R fuses.

#### Non-Fusible Safety Switches

Any brand of circuit breaker or fuse not exceeding the ampere rating of the switch may be used in conjunction with a non-fused safety switch when there is up to 10 kA short circuit current available. (See table below.)

**Above 10, kA**—When applied on systems with greater than 10 kA short circuit current available, the CSA certified short circuit current rating for Square D non-fused switches is based upon the switch being used in conjunction with fuses or Square D circuit breakers.

#### Non-Fusible Safety Switches

Heavy Duty Safety Switch Type	Switch Rating (A) *	Fuse or Circuit Breaker Type **	3 Phase		
			240 Vac	480 Vac	600 Vac
Non-Fusible Switches	All	Any Brand Circuit Breaker	Up to 10 kA		
		H, K	200 kA	200 kA	200 kA
		R, T, J, L	200 kA	200 kA	200 kA
	30-100	H***	65 kA	35 kA	35 kA
	30-100	FA	14 kA	14 kA	14 kA
	30-100	FH	18 kA	18 kA	18 kA
	200	H, J,***	65 kA	35 kA	35 kA
	400	LA	22 kA	22 kA	22kA
	400	LH	25 kA	25 kA	25 kA
	400	L	100 kA	65 kA	65 kA
600	L	100 kA	65 kA	65 kA	

\* Applies to NEMA 1, 3R, 4X stainless, 12 switches.

\*\* Amperage rating of fuse or circuit breaker not to exceed switch amperage rating.

\*\*\* All H and J circuit breakers are acceptable, but will only support the noted Short Circuit Current Rating



# Safety Switches Heavy Duty

## Accessories



### Viewing Windows

Cover viewing windows are positioned over the blades to allow visual verification of "ON-OFF" status. Viewing windows are not available on Type 7/9, 4X Fiberglass-reinforced Polyester Enclosures. Consult the table below for availability on standard Heavy Duty Safety Switches. To order optional viewing windows, factory installed and CSA Certified, add "VW" suffix to standard catalogue number.

**Example:** CH365VW

Ampere Rating	2 and 3-Pole			4 and 6-Pole
	Type 1, 3R	Type 4/4X	Type 3R/12	Type 1, 3R/12
30-200A	Optional	Standard	Standard	Optional
400-600A	Optional	Optional	Optional	Not Available
800-1200 A	Optional	----	Optional	----

For viewing window availability on Double Throw Switches 30-100A Series F, please refer to page DE2-27.

For Safety Switches with viewing windows standard, factory modifications are available to have the switch built without the window.

To order, add "WW" to standard catalogue number.

**Example:** CH361DSWW

### Door-mounted Accessories

Push buttons, pilot lights and selector switches are available factory installed in the cover of Type 1, 4/4X, 3R/12, 600V heavy duty safety switches. For more information please refer to D3110HO0701BP. Voltage indicators are available factory installed in the cover of Type 4/4X, 3R/12, 600V heavy duty safety switches. For more information please refer to D3110HO0601BP or contact Schneider Electric.

### Solid Neutral Assemblies

Solid Neutral Assemblies for 240 & 600V Safety Switches

Fusible, Heavy Duty Safety Switches are suitable for use as service equipment when installed with a Solid Neutral. Solid Neutrals cannot be installed in 4-Pole, 6-Pole Safety Switches.

For factory installation, add "N" suffix to standard catalogue number. If catalogue number is suffixed with "RB", "DS" or "AWK" (enclosure designations), add "N" suffix before enclosure suffix.

**Example:** CH361NDS

Note: Non fused 600V switches does not come with Neutral factory installed. The solid neutral kits has to be ordered separately.

Ampere Rating	Series #	Catalogue Number (Al/Cu)	Terminal Data AWG/kcmil	Catalogue Number (Cu Only)	Terminal Data AWG/kcmil
30	F5-F6	CSN03	(2) 14-3 Al/Cu plus (1) 14-3 Al/Cu Svc Ground	CSN03C	(2) 14-6 Cu plus (1) 14-6 Cu Svc Ground
60	F5-F6 (240 V)		(2) 14-1/0 Al/Cu plus (2) 14-6 Al/Cu Svc Ground		CSN0610C
60	F5-F6 (600 V)	CSN0610	(2)14-1/0 Al/Cu plus (2) 14-6 Al/Cu Svc Ground	CSN0610C	(2)14-1/0 Cu plus (2) 14-6 Cu Svc Ground
100	F5-F6	CSN0610	(2) 6-250 Al/Cu plus (1) 14-10 Al/Cu Svc Ground	CSN20C	(2) 6-250 Cu plus (1) 14-1/0 Cu Svc Ground
200 ■	F5-F6	CSN20	(4) 1-750 Al/Cu plus (1) 4-300 Al/Cu Svc Ground	CH600SNC	(2) 1-600 Cu and (2) 4-350 Cu plus (2) 6-250 Cu Svc Ground
400 - 600	E4-E5	CH600SN	(6) 3/0-750 Al/Cu plus (2)6-350 Al/Cu Svc Ground	----	----
800	E4	H800SNE4	(8) 3/0-750 Al/Cu plus (2) 6-350 Al/Cu Svc Ground	----	----
1200	E4	H1200SNE4			

■ For 200% neutral, order (2) neutral kits and (1) SN20NI neutral jumper kit. (2) 350 Max. Al/Cu.

Note : For series rating not shown in chart refer to the switch wiring diagram.

Note: For 30A switches in 60A enclosures use CSN0610 or CSN0610C

### Solid Neutral Assemblies for Type 7/9 Enclosed

#### Moulded Case Switches

Ampere Rating	Catalogue Number
30	100SNA
60	100SNA
100	100SNA
200	225SNA

### Application Information

- For more information, consult Schneider Electric.



### Electrical Auxillary Interlock Kits

Electrical interlocks for Heavy Duty 30-1200 Ampere Safety Switches are available factory installed or in kit form for field installation. Each kit contains instructions for proper field mounting. A pivot arm operates from switch mechanism, breaking the control circuit before the main switch blades break. Electrical interlock kits are CSA Certified.

For factory installation add "EI" or "EI2" suffix to standard catalogue number.

**Example:** CH361EI

#### Electrical Interlock Kit ▲

Ampere Rating	Series	Catalogue Number
30	F5-F6	EIK031 or EIK032 *
60 (600 V)	F5-F6	EIK1 or EIK2 ★
60 (240 V)	F5-F6	EIK031 or EIK032 *
100-200	F5-F6	EIK1 or EIK2
30-100 Receptacle Switches	F5-F7	EIK1 or EIK2
30-200 4 and 6 Pole Switches	F5-F6	EIK1 or EIK2
400-1200	E4-E5	EIK40601 or EIK40602

- Electrical interlock kit catalogue numbers with -1 suffix indicates one normally open and one normally closed contact; -2 indicates two normally open and two normally closed contacts.
- Not suitable for Elevator use.
- ★ HU461AWK uses EK306-1,2; H461, H461 DS, H461AWK, HU461, HU461DS, HU661DS, HU661AWK, H361AWAVW, CH361AWC, CHU361AWA, CHU361AWC use EIK-1,2.
- \* Safety switches complete with voltage monitors use EIK1 or EIK2.

#### ▲ Electrical Interlock Kit

(Type 4X Fiberglass-reinforced Polyester Enclosure)

Ampere Rating	Catalogue Number (1NO/1NC)	Catalogue Number (2NO/2NC)
30A (F-Series)	9999TC10	9999TC20
60A (F-Series)	9999TC10	9999TC20
100A (F-Series)	9999TC10	9999TC20
200A	9999R8	9999R9

#### Electrical Interlock Contact Ratings ◆

Interlock Type	Volts	AC - 50 or 60 Hz			DC		
		Make	Break	Cont.	Volts	Make & Break	Cont.
1 NO/1 NC CONTACT (-1 Suffix)	120	40A	15A	15A	115	.50A	15A
	240	20A	10A	15A	230	.25A	15A
	480	10A	6A	15A	-	-	-
	600	8A	5A	15A	600	.05A	15A
2 NO/2 NC CONTACTS (-2 Suffix)	120	30A	3.0A	10A	115	1.0A	10A
	240	15A	1.5A	10A	230	.30A	10A
	480	7.5A	.75A	10A	-	-	-
	600	6.0A	.60A	10A	600	.10A	10A

- ◆ Single pole throw interlock kits are rated 1/2 HP @ 110 and 220Vac.
- -1 Suffix utilizes a 9007A01 limit switch.
- -2 Suffix utilizes a 9007C03 limit switch.

### Elevator Rated Electrical Interlocks\*

These interlocks are CSA approved, field installable and can be used in switches with date codes starting with 06454 (year 2006, week 45, day 4 of week) or later.

Ampere Rating	Type 1, 240VAC	Elevator Interlock	Type 1, 600VAC	Elevator Interlock
30	CH321N	EIK031EV	CH361	EIK031EV
60	CH322N	EIK031EV	CH362	EIK06101EV
100	CH323N	EIK06101EV	CH363	EIK06101EV
200	CH324N	EIK201EV	CH364	EIK201EV

\* CSA approved for Type 1, 3R, 4/4X & 3R/12 applications

### Application Information

- For more information, consult Schneider Electric.



### Key Interlock Systems

Factory installed only on Heavy Duty Safety Switches and Double Throw Safety Switches.

Interlocks are used to prevent the authorized operator from making an unauthorized operation. Not available on hazardous location devices (Type 7/9) or fiberglass reinforced polyester (Type 4X).

The Key Interlock System is a simple and easy method of applying individual key interlock units and assemblies to the above equipment so as to require operation in a predetermined sequence.

Quoting: Contact Schneider Electric for catalog number, availability, and pricing prior to quoting a job. Detailed information is required before an order can be processed.

Before preparation of construction equipment with key interlocks can begin, the following information must be known:

1. Ultimate user -name and address
2. Key number, 'SO' number and item number from lock assemblies on any existing locks to be interlocked with.
3. Sketch of sequence of operations to be accomplished and name and phone number of specifying engineer. Confirmation from customer is required before an order is released for production.
4. Other Square D equipment interlocked - order point, order numbers, etc. for coordination.
5. Schneider Electric key interlocks will be furnished unless otherwise specified.

To order, add "KI", "KI2" or "KIKI" suffix to standard catalogue number. Contact your local Schneider Electric office for a reference number prior to entering the order.

**Example:** CH364KI

KI = 1 lock per switch

KI2 = 1 lock with 2 cylinders per switch

KIKI = 2 separate locks per switch

### Lock-On Provisions

Provision for one 3/8 inch hasp padlock is available factory installed on Types 1, 3R, 4/4X stainless steel and 3R/12 switches. This modification will allow the switch to be locked in the "ON" position.

To order, add "SPLO" suffix to standard catalogue number.

**Example:** CH361SPLO



### Lock-Off Guard

Designed for use with safety switches in commercial and industrial settings, Lock-Off Guard enhances the reliability of lockout procedures to isolate power in daily activities and provide an effective way to interrupt power in an emergency.

The innovative Lock-Off Guard works by covering the lockout/tag-out opening whenever the switch is in the "ON" position, preventing a padlock from being inadvertently inserted into the switch lockplate.

This device is designed to help prevent accidents caused by an untrained or distracted employee, who could inadvertently attempt to apply a lockout device to a switch without turning the switch to "OFF."

- Installs on Square D 30A to 200A F series Type 1, 3R and 12 switches in less than 30 seconds.

- Bright red colour reminds users of the seriousness of lockout/tag-out procedures.

60A 600V and 100A 240V or 600V switches prior to series F05 require the handle and mechanism be upgraded in order to install the kits.

These kits are marked cURus for field or factory installation.

#### Field Installation Kits

Ampere rating

- 30A
- 60A 240V
- 60A 600V
- 100A and 200A

Catalogue number

- LOGK1
- LOGK1
- LOGK2
- LOGK2

**Factory Installed option is available**

Order using "LOG" suffix on standard switch catalogue numbers.

# Safety Switches Heavy Duty

## Accessories

### Rainproof Bolt-On Hubs —

For Use On Type 3R Enclosures

Conduit Size	3/4	1	1 1/4	1 1/2	2	2 1/2	3	3 1/2	4	Closing Cap
Rainproof Hub Cat. No.	B075	B100	B125	B150	B200	B250	B300	B350	B400	BCAP

- Type 3R rainproof enclosures have a bolt-on closing cap factory installed. Order bolt-on hubs separately from table above.
- Hubs thru size 2 1/2 can be directly installed on RB devices. Devices requiring 3" or larger hubs must have holes cut in the field. Gaskets are provided on 3" and larger hubs.
- All hubs are CSA Certified for indoor and rainproof applications.



"RB Hub"

### Watertight Hubs —

For Use On Type 4/4X Stainless Steel and Type 3R/12 Enclosures

Conduit Trade Size	1/2	3/4	1	1 1/4	1 1/2	2	2 1/2	3	3 1/2	4
Standard-Zinc Hub Catalogue Number	H050	H075	H100	H125	H150	H200	H250	H300	H350	H400
Chrome Plated Hub Catalogue Number	H050CP	H075CP	H100CP	H125CP	H150CP	H200CP				

Note: Gaskets are provided.

### Equipment Grounding Kits

Canadian Safety Switches come complete with factory installed Grounding Kits. Additional Grounding Kits are available for field or factory installation in 30-1200 Ampere, 240 & 600 Volt Heavy Duty Switches.

For factory installation, add "GL" suffix to standard catalogue number.

Example: CH361GL

Ampere Rating	Series	Catalogue Number (Al/Cu)	Terminal Data AWG/kcmil	Catalogue Number (Cu Only)	Terminal Data AWG/kcmil
30	F5-F6	GTK03	(2) 14-4 Cu or (2) 12-4 Al or (4) 14-12 Cu or (4) 12-10 Al	GTK03C *	(2) 14-6 Cu
60	F5-F6 (240 V)				
100	F5-F6 (600 V)	GTK0610	(2) 14-1/0 Cu or (2) 12-1/0 Al and (2) 14-6 Cu or (2) 12-6 Al	GTK0610C	(2) 14-1/0 Cu and (2) 14-6 Cu
200	F5-F6	PKOGTA2	(2) 10-2/0 Cu or (2) 6-2/0 Al	PKOGTC2	(2)-14-4 Cu
400-600	E4-E5	PKOGTA2 (2 Required) ◆	(2) 10-2/0 Cu or (2) 6-2/0 Al	PKOGTC3	(4) 14-1/0 Cu
800	E4	PKOGTA7	(4) 4-350 Al/Cu	----	----
1200	E4	PKOGTA8	(8) 4-350 Al/Cu	----	----

◆ Two required if grounding conductors are run in parallel.

\* Optional Copper equipment grounding kit for the 4and 6 Pole 30A F series : H461DS, H461AWK, HU461DS, HU661DS and HU661AWK accepts GTK03C and HU461AWK accepts GTK0610C.

Note: For equipment grounding kits for the 30A switches inside 60A enclosures please refer to the switch wiring diagram.

### Terminal Lug Data ■

Ampere Rating	Conductors Per Phase	Type 1, 3R, 4/4X & 3R/12 Wire Range AWG/Kcmil	Type 7/9 Wire Range AWG/Kcmil
30 ▲	1	12-2 (Al) or 14-2 (Cu)	
60	1	12-2 (Al) or 14-2 (Cu)	Use 75 °c copper wire only. #6 AWG Copper wire required for 60A rating
100	1	12 - 1/0 (Al) or 14 - 1/0 (Cu)	Use 75° C copper wire only. #3 AWG copper wire required for 100A rating.
200	1	6 - 300 (Al/Cu)	Use 75° C copper wire only. Lug wire range is #3 AWG-350 kcmil. not UL/CSA listed due to inadequate wire bending space.
400	1 or 2	1/0 - 750 (Al/Cu)▼ or 1/0 - 300 (Al/Cu)	
600	2	3/0 - 500 (Al/Cu)	
800	3	3/0 - 750 (Al/Cu)	
1200	4	3/0 - 750 (Al/Cu)	

■ 30-100 Amp switches suitable for 60°C or 75°C conductors. 200-1200 Amp switch suitable for 75°C conductors.

● Option sized lugs not available.

▲ HU461AWK - #14 - 6 AWG (Cu).

▼ Max. wire range (1) 600 kcmil or (2) 300 kcmil Al/Cu on Type 4/4X Stainless and Type 12.

### Application Information

- For more information, consult Schneider Electric.

### Copper Lugs

Heavy Duty safety switches are supplied standard with Al lugs, which accept both Cu and Al wires.

Not available for use on NEMA Type 4X Fiberglass, or Type 7 and 9 switches.

For factory installation of copper only lugs add "SLC" suffix to standard catalogue number. CSA Certified.

**Example:** CH361SLC

For field installation of copper only lug kits, order kits below.



### Kits

Switch Amperage	Lug Kit Catalogue Number	Lug Wire Range AWG/kcmil
30-60	CL0306F	(1) 14-8 Cu Solid or 14-4 Cu Standard
100	CL10F	(1) 14-8 Cu solid or 14-1/0 Cu standard
200	CL20F	(1) 6-250 Cu
400	CL40F	(1) 1-600 Cu plus (1) 6-250 Cu
600	CL60F	(1) 4-350 Cu
800	-	-
1200	-	-

Note: One kit includes all phase line/load lugs for a 3-pole switch. CL0306F, CL10F and CL20F includes six lugs. CL40F and CL60F includes 12 lugs

### Double Lug Kits

200 A heavy duty F-series switches are supplied standard with lugs suitable for one wire per phase. For two wires per phase and neutral, order the Double Lug Kit.

Not listed on switch's wiring diagram as an accessory.

Ampere	Catalogue Number	Lug Wire Range per Phase and Neutral AWG/ kcmil
200	AL20DTF	(2) 6-300 Cu/Al

### Compression Lug Kits (800 and 1200A)

Compression lug kits are available for field and factory installation. Each kit consists of VCEL-075-12H1 VERSA- CRIMP compression Lugs and lug landing connectors capable of converting line and loadside of one switch pole or neutral.

CSA certified.

Order one field - installable kit per pole or neutral.

**Example:** 3-pole, 3 wire requires 3 kits; 3-pole, 4 wire requires 4 kits.

Switch Amperage	Lug Kit Catalogue Number	Compression Lug(VCEL-075-12H1) Wire Size
800	H8LKE2	500-750 Kcmil(Al) or 500 Kcmil(Cu)
1200	H12LKE2	

For factory installation, add "LK" suffix to standard catalogue number.

**Example:** CH367LK

### Switch Lubricant

Catalogue Number SWLUB is a field maintenance lubricant for servicing blade/jaw components in safety switches, 600V and below. SWLUB consists of one 5.3 ounce of BJ20 High Performance Synthetic Grease by Dow Corning®, which has an operating temperature range from -45° to 180° Celsius.

Description	Catalogue Number
Field Maintenance Lubricant	SWLUB

### Square D Grey Touch-up Paint

Description	Catalogue Number
12 oz. Aerosol Paint Can, Square D ANSI-49 Gray Touch-Up Paint	PK49SP

### Application Information

- For more information, consult Schneider Electric.
- Dow Corning® is a Registered Trademark of Dow Corning Corporation.

### Phenolic Legend Plates

Available engraved and mounted on all Heavy Duty Safety Switches except Type 7/9. Legend engraved in 1/4 inch high white letters on black background. Customer must provide legend.

To order, add "NP" suffix to standard catalogue number.

**Example:** CH361NP(Pump)

### Special Paint

CSA Certified Heavy Duty Switches are available painted with special safety colours. Special colours available are safety red, safety orange, safety yellow, safety green, safety blue, radiant purple, black and white. The special epoxy chemical resistant finish paint is applied over our standard grey finish.

Not available on NEMA 4X Fiberglass, NEMA 4/4X/5 Stainless steel nor NEMA 7 and 9.

**A minimum quantity of 10 is required.**

Order by description.

**Example:** CH361SP

### Internal Barrier Kits

These barriers provide added protection when a switch door is open. cUL recognized components.

#### Internal Barrier Kits for 30-200A HDSS

Catalogue Number	Description	Switch Ampere Application (F Series only)
SS03	Interior Barrier for 30A Safety Switch★	240Vac, 600Vac-30A 240Vac-60A
SS06	Interior Barrier for 60A Safety Switch	600Vac-60A
SS10	Interior Barrier for 100A Safety Switch	240Vac, 600Vac-100A
SS20	Interior Barrier for 200A Safety Switch	240Vac, 600Vac-200A

★ Requires arc shield on 240V switches be changed to 600V arc suppressor. Arc suppressor must be purchased separately.

#### Internal Barrier Kits for 800-1200A HDSS

Catalogue Number	Description
SS80120LI	Additional line barrier for 800-1200A, 600V Series E04 Heavy Duty Safety Switch
SS80120LO	Additional load barrier for 800-1200A, 600V Series E04 Heavy Duty Safety Switch



### Voltage Monitors

Voltage monitors installed on safety switches indicate when voltage is present, helping to prevent arc-flash hazards and electric shocks during maintenance work. Voltage monitors can be combined with other safety features such as Key Interlock, Viewing Windows or Lock-ON provisions

- CSA Listed
- Factory installed only
- Order the voltage monitors by adding the appropriate suffix shown in the table below to the switch catalog number
- Not available on NEMA 7 and 9 and NEMA 4X Fiberglass switches.

#### Voltage Monitors \*

Description	Suffix
Line Side Monitor	SI
Load Side Monitor	LI
Line and Load Side Monitor	LI2

\*Available on 30-1200 A Heavy Duty Safety Switches and 30-400 A Double Throw Safety Switches

Note: For switches 60 amps or less, indicators require use of 100A size enclosure. Add "3" to the catalog number prior to second set of alphabetical characters (e.g., CH361AWK becomes CH3613AWKLI for load indicator).



# Safety Switches

## Double Throw Types 82,000, 92,000 and DTU (A-Series)

### Accessories

#### Electrical Interlocks

Electrical interlocks for Double Throw Safety Switches are available in kit form for field installation only.

Ampere Rating	Catalogue Number
30 Series T4	N/A
C82344	EK200DTU2
200 4P Series E	EK400DTU2
400 Series A	EK400DTU2
600 Series A	DS200EK2D

#### Electrical Interlock EK200DTU2 Contact Ratings ◆

Interlock Type	Volts	AC - 50 or 60 Hz			DC		
		Make	Break	Cont.	Volts	Make & Break	Cont.
2 NO/2 NC CONTACTS (-2 Suffix)	120	30A	3.0A	10A	115	1.0A	10A
	240	15A	1.5A	10A	230	.30A	10A
	480	7.5A	.75A	10A	-	-	-
	600	6.0A	.60A	10A	600	.10A	10A

◆ Single pole throw interlock kits are rated 1/2 HP @ 100 and 220Vac.

#### Solid Neutral Assemblies

Solid Neutrals are available for field installation only.

Ampere Rating	Catalogue Number	Terminal Data AWG/Kcmil
30 Series T4	DT30SN	14-8 Cu/Al
200 3P Series E	225SNA	6-300 Cu/Al
200 4P Series E	DT200N	4-250 Cu/Al
400 Series A	DT400N	(1) 1/0-600 Al/Cu or (2) 1/0-250 Al/Cu plus (2) 6-300 Al/Cu Svc Ground
600 Series A	DT600NKD	(6) 250-500 Al/Cu plus (1) 6-250 Al/Cu Svc Ground

#### Terminal Lug Data for Type 82,000, 92,000, and DTU (Series A) ▼

Ampere Rating	Wires per Phase	Wire Range AWG/kcmil Al/Cu
30 A (Series T4) ▼	1	14-8 Al/Cu
200	1	6-300 Al/Cu
400	1 or 2	1/0- 600 Al/Cu or 1/0-300 Al/Cu
600	2	250-500 Al/Cu

▼ 200-600 A switches suitable for 75° C conductors.

▽ 30 A switches suitable for 60° C or 75° C conductors.

#### Lock-On Provisions

Lock-on provisions are standard on all 82,000 and 92,000 Line Double Throw Safety Switches.

#### Equipment Grounding Kits

Ampere Rating	Catalogue Number	Terminal Data AWG/kcmil
30A Type 92,000	DT30SG	(4) 14-4 Cu/Al
200A Type 82,000	DT100SG	(3) 14-1/0 Cu/Al
400A Type 82,000	PKOGTA2 (2 Required)	(4) 10-2/0 Cu or (4) 6-2/0 Al
600A Type DTU	DS468GKD	(2) 6-250 Al/Cu

#### Key Interlock Systems

For factory installed Key Interlocks refer to Heavy Duty accessories section.

#### Phenolic Legend Plate

For factory installed Legend plates, refer to Heavy Duty accessories section.

#### Viewing Windows

Not available.

### Application Information

- For more information, consult Schneider Electric.

#### Electrical Interlocks

Electrical interlocks for Double Throw Safety Switches are available in kit form for field installation. Each kit contains instructions for proper field mounting. Electrical interlock kits are furnished with 2NO/2NC contacts and are installed in both "ON" positions, when factory installed.

Ampere Rating	Catalogue Number
30 - 100A	EIK1 or EIK2 ★

★ 30-100 A Type DT, DTU (Series F) switches contain (2) separate switching mechanisms. Each mechanism will accept an electrical interlock. Some applications may therefore require (2) electrical interlocks.

For factory installation, add "EI" suffix to standard catalogue number.

**Example:** DTU362EI

#### Solid Neutral Assemblies

Solid Neutrals are available for field installation on two and three pole Switches.

Ampere Rating	Catalogue Number	Terminal Data AWG
30 - 100	SN0310	(3) 14-1/0 Al/Cu plus (2) 14-6 Al/Cu Svc Ground
30 - 100	SN0310C	(3) 14-1/0 Cu plus (2) 14-6 Cu Svc Ground

#### Fuse Puller

Kit consists of three fuse pullers and can be installed in all double throw switches.

Ampere Rating	Catalogue Number
30 - 100A series F	FPK0610

#### Rainproof Bolt-On Hubs —

Please refer to Heavy Duty accessories section for more information.

#### Watertight Hubs —

Please refer to Heavy Duty accessories section for more information

#### Terminal Lug Data for Type DT, DTU (Series F) Double Throw Safety Switches

Switch Ampere Rating	Wires per Phase	Type 1, 3R, 4, 4X, 12
		Wire Range AWG/kcmil Al/Cu
30-60 A, Type DT, DTU (Series F)	1	12-2 (Al) or 14-2 (Cu)
100 A, Type DT, DTU (Series F)	1	12-1/0 (Al) or 14-1/0 (Cu)

#### Lock-On Provisions

Lock-on provisions are standard on all 30-100 A Type DT, DTU (series F) Double Throw Safety Switches.

#### Equipment Grounding Kits

Ampere Rating	Catalogue Number
30 - 100	Included

#### Key Interlock Systems

For factory installed Key Interlocks refer to Heavy Duty accessories section.

#### Phenolic Legend Plate

For factory installed Legend Plates, refer to Heavy Duty accessories section.

#### Class R Fuse Provisions

##### Class R Fuse Kits

When installed, this kit rejects all but Class R fuses. Kits are available for field installation. Two kits per 3P switch. For factory installation, add "CLR" suffix to catalogue number.

**Example:** DT362CLR

Ampere Rating	Series	Catalogue Number
30 (240V)	F5	RFK03
30 (600V)	F5	RFK06
60 (240V)	F5	RFK06
60 (600V)	F5	RFK06H
100	F5	RFK10

#### Viewing Windows

To order optional viewing windows factory installed add "VW" suffix to standard catalogue number. Viewing window is not an offer in all double throws, please consult with your local distributor to obtain more information

**Example:** DTU362AWKVV.

# Safety Switches

## General Duty

### Accessories

#### Electrical Interlock Kits

Electrical interlocks for F-Series 60-200 Ampere General Duty Safety Switches are available factory installed or in kit form for field installation. Each kit contains instructions for proper field mounting. A pivot arm operates from switch mechanism, breaking the control circuit before the main switch blades break. Electrical interlock kits are CSA Certified.

Ampere Rating	Catalogue Number
60(F-Series)	EIK031, or EIK032
100-200	EIK1 or EIK2

- Electrical interlock kit catalogue number with -1 suffix indicates one normally open and one normally closed contact; -2 indicates two normally open and two normally closed contacts.
- For Electrical Interlock contact ratings, see page DE2-23.

For factory Installation, add "EI" or "EI2" to standard catalogue number.

**Example:** CD223NEI

#### Class R Fuse Kits

CSA Certified Rejection kits are available for E-Series and F-Series Safety Switches. When installed, this kit rejects all but Class R fuses. Kits are available for field installation.

For factory installation, add "CLR" suffix to standard catalogue number.

**Example:** CD222NCLR

Ampere Rating	Catalogue Number
30*	DRK30
60 (F-series)	RFK03H
100 (F-Series)	RFK10
200	HRK1020
400	DRK40
600	DRK600

\* Except L111N & CD211N

#### Class J Fuse Kits

Provision for installing Class J fusing in 600 ampere devices is available when lug kit GDJK600 is used. Conversion to Class J fuse spacing for 400 ampere devices requires relocating the loadside fuse base assembly from the standard Class H fuse location to an alternative position as marked in the enclosure. With Class J fuses installed, the switch is CSA certified for use on systems with up to 100,000 RMS symmetrical amperes. For field installation only.

Ampere Rating	Catalogue Number
600 Type 1	GDJK600

#### Fuse Puller Kits

Kit consists of three fuse pullers, and can be installed in 60 and 100 Ampere F-Series Safety Switches.

Ampere Rating	Catalogue Number
60 (F-Series)	FPK03
100 (F-Series)	FPK0610

#### Equipment Grounding Kits

Canadian general duty safety switches come complete with factory installed Grounding kits. Additional Grounding Kits are available for field or factory installation.

Ampere Rating	Catalogue Number	Wire Size AWG
30	PK3GTA1	(3) 14-4 Cu or (3) 12-4 Al or (6) 14-12 Cu or (6) 12-10 Al
60	GTK03	(2) 14-4 Cu or (2) 12-4 Al (4) 14-12 Cu or (4) 12- 10 Al
100	GTK0610	(2) 14-1/0 Cu or (2) 12-1/0 Al (2) 14-6 Cu or (2) 12-6 Al
200	PKOGTA2	(2) 10-2/0 Cu or (2) 6-2/0 Cu Al
400 600	PKOGTA2 (two required)	(2) 10-2/0 Cu or (2) 6-2/0 Cu Al

#### Optional Lug Kit

Kit consists of three line, three load and two neutral lugs as required for a 3-pole 400A or 600A general duty switch.

Ampere Rating	Catalogue Number	Wire Size AWG/Kcmil
400 or 600A Type 1 (Series E3)	GD4060LK	2-1/0-600 kcmil 4-1/0-250 kcmil

### Application Information

- For more information, consult Schneider Electric.



# Safety Switches Application Information

## Enclosures

Provides Protection Against...	Enclosure Type															
	Non-Hazardous Locations								Hazardous Locations							
	1	2	3	3R	4	4X	5	12	7A	7B	7C	7D	9E	9F	9G	
Accidental contact with enclosed equipment	X	X	X	X	X	X	X	X	X	X	X	X	X	X	X	
Dripping and light splashing of non corrosive liquids		X	X	X	X	X	X	X								
Limited amounts of falling dirt	X	X	X	X	X	X	X	X								
Windblown dust			X		X	X										
Rain, sleet, and external ice formation			X	X	X	X										
Hose directed water					X	X										
Corrosion						X										
Settling airborne dust, lint, fibers, and filings			X		X	X	X	X								
Circulating dust			X		X	X		X								
Acetylene									X							
Hydrogen, manufactured gas										X						
Ethyl ether, ethylene, cyclopropane										X	X					
Gasoline, hexane, naphtha, benzene, butane, propane										X	X	X				
Alcohol, acetone, benzol, natural gas, lacquer solvent										X	X	X				
Metal dust													X			
Carbon black, coal dust, coke dust														X		
Flour, starch, grain dust														X	X	
<b>Usage</b>																
Indoors	X	X	X	X	X	X	X	X	X	X	X	X	X	X	X	
Outdoors			X	X	X	X										

## Application Information

- For complete enclosure definitions, refer to C22.2 No. 94
- HP Rating: Standard value when using fast acting one time fuses. Max. value when using dual element time delay fuse.
- For more information, consult Schneider Electric.