

I-Line™ Circuit Breaker Panelboards

Class 2110

Catalog

2110CT9701
R02/2020



Legal Information

The Schneider Electric brand and any trademarks of Schneider Electric SE and its subsidiaries referred to in this guide are the property of Schneider Electric SE or its subsidiaries. All other brands may be trademarks of their respective owners.

This guide and its content are protected under applicable copyright laws and furnished for informational use only. No part of this guide may be reproduced or transmitted in any form or by any means (electronic, mechanical, photocopying, recording, or otherwise), for any purpose, without the prior written permission of Schneider Electric.

Schneider Electric does not grant any right or license for commercial use of the guide or its content, except for a non-exclusive and personal license to consult it on an "as is" basis. Schneider Electric products and equipment should be installed, operated, serviced, and maintained only by qualified personnel.

As standards, specifications, and designs change from time to time, information contained in this guide may be subject to change without notice.

To the extent permitted by applicable law, no responsibility or liability is assumed by Schneider Electric and its subsidiaries for any errors or omissions in the informational content of this material or consequences arising out of or resulting from the use of the information contained herein.

Table of Contents

Product Description	5
Standards	5
Service	6
Panelboard Types	7
Enclosure Types.....	8
Main Breaker Panelboards	9
Main Lugs Only Panelboards.....	9
Solid Neutral	9
Features and Benefits	10
Circuit Breakers.....	10
Circuit Breaker Mounting	10
Push-to-Trip	10
Blow-On Connections	11
Short Circuit Current Rating (SCCR)	11
I-Line Plug-on Unit with SurgeLogic™ SPD	11
Accessories	12
Equipment Ground Bars.....	12
Box Extensions	12
Blank Fillers	12
Backfed Main Breaker Barriers	12
General and Application Information	13
Circuit Breaker Terminal Data	14
Circuit Breaker Accessories.....	15
Plug-On Lugs Terminal Data.....	15
Plug-On QO™ Distribution Panel (Catalog No. HQO306)	16
QO Distribution Panel Branch Circuit Breakers	16
Circuit Breaker Types.....	17
Dimensions	19
Type HCJ—800 A Maximum Main Lugs	19
Type HCJ 400 A Maximum Main Circuit Breaker	21
Type HCJ—800 A Maximum Main Circuit Breaker.....	23
Type HCP—800 A Maximum Main Lugs.....	25
Type HCP—1200 A Maximum Main Lugs	27
Type HCP—800 A Maximum Main Circuit Breaker	29
Type HCP-SU—800 A Maximum Main Circuit Breaker	31
Type HCR-U—1200 A Main Lugs or Main Circuit Breaker	33

Product Description

**Type HCR-U—
1200 A Main
Circuit Breaker**



Square D™-brand I-Line™ circuit breaker power distribution panelboards are for use on AC or DC systems. The panels, labeled cULus (compliance to UL and CSA standards certified by UL) are also Underwriters Laboratories® (UL®) Listed under File E33139. The following are suitable for use as service entrance equipment:

- All main circuit breaker panelboards.
- All main lugs panelboards with branch-mounted, back-fed main circuit breaker. (For Canadian MLO service entrance, use HCP-SU and HCR-U only).
- All main lugs panelboards with six disconnects or less.
- A solid neutral that is insulated, but may be bonded to the box with a grounding strap.
- Service entrance panelboards meeting the requirements of CSA are available in Canada factory-assembled only.

I-Line circuit breaker panelboards are available as 400–1200 A main lugs only and 100–1200 A main circuit breakers. I-Line panelboards are designed to accept the following circuit breakers: FA, FH, BD, BG, BJ, BK, HD, HG, HJ, HL, HR, QB, QD, QG, QJ, JD, JG, JJ, JL, JR, LA, LD, LG, LJ, LH, LL, LR, MG, MJ, PG, PJ, PK, PL, RG, RJ, RK, and RL.

Standards

**Type HCR-U—
1200 A
Main Circuit Breaker**



I-Line circuit breaker panelboards are designed, manufactured, and tested to comply with the following standards:

Standard	Description
UL 50	Standard for enclosures for electrical equipment
UL 67	Standard for panelboards
CSA C22.2, Nos. 29 and 94—1989	Standard for panelboards and enclosed panelboards
NFPA 70	National Electrical Code (NEC)
NEMA PB 1	Standard for panelboards
W-P 115C Type 1 Class 1	Specification for circuit breaker panelboards
2000 IBC	US standard for seismic requirements
1995 NBCC	Canadian standard for seismic requirements

Service

I-Line circuit breaker panelboards can be used on the following system voltages:

- 120/240 Vac; 1-phase, 3-wire
- 240 Vac; 1-phase, 2-wire
- 240 Vac; 3-phase, 3-wire
- 240 Vac Ground, B-phase; 3-phase, 3-wire
- 208Y/120 Vac; 3-phase, 4-wire
- 480Y/277 Vac; 3-phase, 4-wire
- 480 Vac; 3-phase, 3-wire
- 600Y/347 Vac; 3-phase, 4-wire
- 600 Vac; 3-phase, 3-wire
- 125/250 Vdc; 3-wire
- 250 Vdc; 2-wire

Panelboard Types

**Type HCP—600 A
Main Circuit Breaker**



Panel-board Type	Maximum Mains Ampacity		Maximum Branch Circuit Breaker Frame Size ¹		Enclosure Dimensions ²			
	Main Lugs	Main Circuit Breakers	Left	Right	Width		Depth#	
					in.	mm	in	mm
HCJ	800 A	800 A	JD	JD	32.00	813	9.50	241
HCP-SU	800 A	800 A ³	MG, PG	None	26.00	600	9.50	241
HCP	1200 A	800 A ³	MG, PG	JD	42.00	1067	9.50	241
HCR-U	1200 A	1200 A ³	RG	JD	44.00	1118	9.50	241

**Type HCP-SU 800 A Main
Circuit Breaker**



Type HCJ—400 A Main Lugs



1. For a complete listing of applicable circuit breaker types, refer to Dimensions, page 19.
 2. Refer to Dimensions, page 19 for standard panelboard heights.
 3. Available as a main circuit breaker panelboard when provided with a branch mounted back-fed main circuit breaker.

Enclosure Types

Types 1 and 2 Enclosure with Optional Door



Flush Lock used on HCJ, and HCP-SU Types 1 and 2 Fronts (Catalog No. PK4FL)

Sliding Vault Lock used on HCP, and HCR-U Types 1 and 2 Fronts (Catalog No. PK5FL)



Types	Environments	Provides Protection Against
Type 1	Indoor	Contact with the enclosed equipment
Type 2	Indoor	Falling water and dirt
Type 3R	Outdoor	Falling rain, sleet; undamaged by ice
Type 4/4X Stainless	Indoor/Outdoor	Corrosion, hose-directed water, dust
Type 5	Indoor	Settling dust, falling dirt, dripping liquids
Type 12	Indoor	Circulating dust, falling dirt, dripping liquids

Type 1 Enclosures	Fronts:	HCJ, HCP, HCP-SU, and HCR-U surface and flush trims available as four-piece construction, standard (door not included). An optional four-piece trim with door is also available.
		Finished with gray-baked enamel electrodeposited over cleaned phosphatized steel (ANSI 49).
		Directory card holders provided with all fronts.
	Boxes:	Galvanized steel in 26, 32, 42, and 44-inch (660, 813, 1067, and 1118 mm) widths.
		Removable endwalls without knockouts.
Type 3R, 5, and 12 Enclosures		Gasketed door with vault handle and directory card holder.
		Three-point latching.
		End and side gutter trim.
		No knockouts.
		Removable drain screw for Type 3R.
Type 4X Enclosures (Factory-Assembled Only)		Finished with gray-baked enamel electrodeposited over cleaned phosphatized steel (ANSI 49).
		Corrosion-resistant, stainless steel.
		Watertight and dusttight.
		Gasketed door.
		Directory card located on inside of door.

Type 3R, 5, and 12 Enclosures



Type 3R, 5, and 12 Enclosures



Vault Handle used on all Type 3R, 5, and 12 Enclosures (Catalog No. PK4NVL)



Main Breaker Panelboards

Main Circuit Breaker and Solid Neutral Compartment (Canada service entrance not shown)



- Accept a maximum 1200 A, 80% or 100% rated main breaker.
- Available factory-assembled or merchandised.
- Factory-assembled main circuit breaker interiors are available bottom-feed or top-feed.
- Suitable for use as service entrance equipment with appropriate barriers, US and Canada.
- Accepts mechanically restrained I-Line circuit breakers.
- Available with a short circuit current rating (SCCR) up to 200 kA maximum (100 kA @ 600 Vac) when supplied by an I-Limiter™ circuit breaker.
- Available with a silver-plated or tin-plated copper bus, or tin-plated aluminum bus.
- Solid neutral is mounted in the mains compartment with the main circuit breaker.
- Merchandised panelboards are provided as bottom-feed.

Main Lugs Only Panelboards

Main Lug and Solid Neutral Compartment



- Available with main lug only interiors rated up to 1200 A.
- Available factory-assembled or merchandised.
- Suitable for use as service entrance equipment when provided with a main circuit breaker, US and Canada.
- Accepts mechanically restrained I-Line circuit breakers.
- Available with a short circuit current rating (SCCR) up to 200 kA maximum (100 kA @ 600 Vac) when supplied by an I-Limiter circuit breaker.
- Available with a silver-plated or tin-plated copper bus, or tin-plated aluminum bus.
- Solid neutral is mounted in the mains compartment with the main lugs.
- Hinged cover, isolated main lugs compartment.
- Main lug interiors are available as top-feed or bottom-feed.

Solid Neutral

- Mounts in main lug or main circuit breaker compartment.
- Does not take up interior circuit breaker mounting space.
- UL/CSA Listed for use with Al or Cu conductors.
- Copper or aluminum neutral available.
- 200% rated neutral available as a factory-assembled option.

Typical Solid Neutral

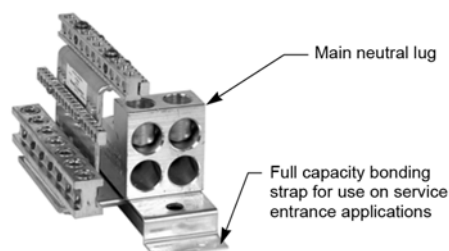

Neutral with C/T for Use on HCR-U When Ground-Fault Protection is Required (Catalog No. HCR12SNCT)



Features and Benefits

Featured below are just a few of the many features and benefits of Square D™ brand I-Line™ circuit breaker panelboards.

Circuit Breakers

I-Line circuit breakers, with their exclusive bus connection design, provide superior reliability and performance advantages.

Circuit Breaker Mounting

Ratchet-Type Mounting



- 15–1200 A frame circuit breakers require only a screwdriver and are firmly attached to the bus stack and mechanically attached to the interior assembly.
- The connectors are an integral part of the I-Line circuit breaker—eliminating the assembly of connectors to the bus bar.
- Pre-assembled hardware means reduced installation time.
- The unique line side connection requires no routine maintenance.

I-Line Bus Structure and Circuit Breaker Mounting

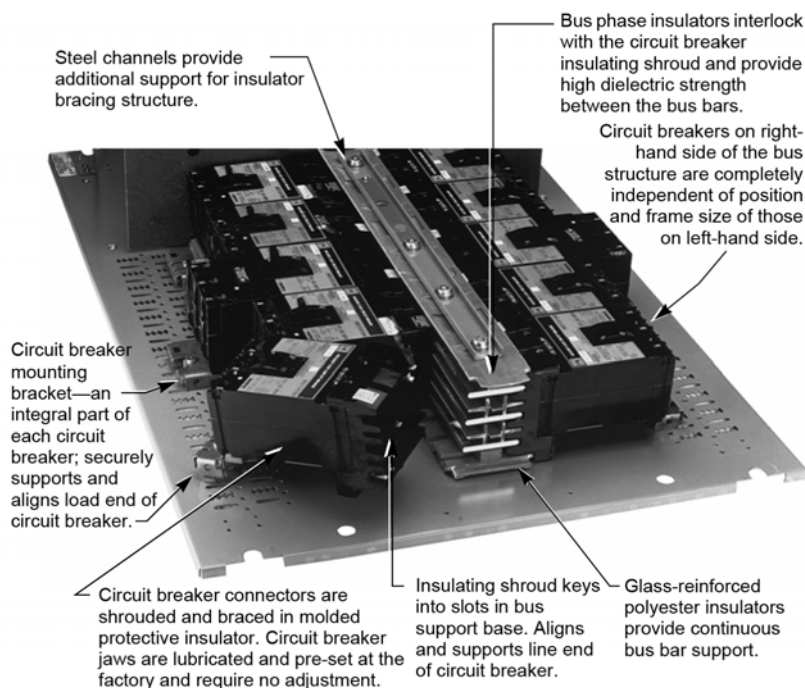

Push-to-Trip

Push-to-trip is a standard feature on all I-Line circuit breakers. It is useful for checking circuit breaker operation and for testing auxiliary devices. The circuit breaker is mechanically tripped by pressing the push-to-trip button in the circuit breaker case.

Blow-On Connections

Blow-On Connections

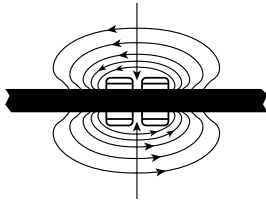

All circuit breaker connections are “blow-on” type. Under high-level short circuit conditions, the magnetic forces developed tend to draw the connector jaws together, gripping the I-Line bus bar more firmly.

Short Circuit Current Rating (SCCR)

- SCCR is equal to the lowest interrupting capacity of a branch or main circuit breaker installed in the panelboard.
- I-Line panelboards, with branch circuit breakers installed, are short-circuit tested as complete units.
- All tests are conducted in accordance with UL 67 and CSA C22.2 (Standards for Panelboards).

With I-Limiter main circuit breaker, I-Line main circuit breaker panelboards are UL/CSA Listed for use on systems with up to a 200,000 maximum RMS symmetrical amperes available fault current (100 kA @ 600 Vac).

I-Line Plug-on Unit with Surgelocic™ SPD

I-Line Plug-On Unit with Surgelocic SPD

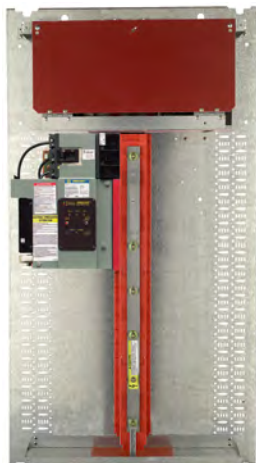

- SPD requires no wiring or conduit, saving labor time and materials.
- Bus-connected design enhances performance.
- Meets the requirements of UL and CSA for retrofit applications in existing I-Line panelboards and switchboards.
- Integrated and circuit breaker disconnects feature compact design, requiring only 13.50 inches (343 mm) of branch mounting space.
- SCCR up to 200 kA rating (100 kA @ 600 Vac) meets a wide variety of customer applications.

Accessories

A wide variety of accessories are available for field or factory installation of I-Line panelboards.

Equipment Ground Bars

Equipment Ground Bar
(Catalog No.
PK32DGTA)

Equipment ground bars mount in the panelboard box to provide convenient termination of equipment grounding conductors. They are available in copper or aluminum.



Box Extensions

Typical Box Extensions

Box extensions provide additional end gutter for feeding cables into the end of the cabinet; they are UL/CSA Listed.



Blank Fillers

Blank Fillers
(Catalog Nos.
HNM4BL and HNM1BL)

Blank fillers are required to cover unused mounting space in I-Line panelboards.



Backfed Main Breaker Barriers

Primarily for use in Canada, these barriers provide additional protection for backfed main breakers.

General and Application Information

Please refer to Digest Section 9 for circuit breaker ratings information.

Circuit Breaker Frame Type	Maximum Voltage Rating	Number of Poles	Cont. Ampere Rating	UL/CSA Interrupting Rating—RMS Amperes (Symmetrical)					
				AC Volts, 50/60 Hz				DC Volts	
				120	240	480	600	125	250
FA 240 V	240	2	15–100	10 K	25 K	—	—	—	5 K
		3							
FA 480 V	277	1	35–100	25 K	25 K	18 K	—	10 K	10 K
	480	2	15–100						
		3							
FH ⁴	277	1	15–30	65 K	65 K ⁵	25 K	—	10 K	—
	600	2, 3	35–100		25 K ⁵				
				15–100	—	—	—	18 K	—
BD	600 Y	1, 2, 3	15–125	25 K	25 K	18 K	14 K	—	—
BG	600 Y	1, 2, 3	15–125	65 K	65 K	35 K	18 K	—	—
BJ	600 Y	1, 2, 3	15–125	100 K	100 K	65 K	25 K	—	—
BK	600 Y	1, 2	15–30	100 K	100 K	65 K	65 K	—	—
HD	600	2, 3	15–150	25 K	25 K	18 K	14 K	20 K	20 K
HG	600	2, 3	15–150	65 K	65 K	35 K	18 K	20 K	20 K
HJ	600	2, 3	15–150	100 K	100 K	65 K	25 K	20 K	20 K
HL	600	2, 3	15–150	125 K	125 K	100 K	50 K	20 K	20 K
HR	600	3	15–150	200 K	200 K	200 K	100 K	—	—
QB	240	2, 3	70–225	10 K	10 K	—	—	—	—
QD	240	2, 3	70–225	25 K	25 K	—	—	—	—
QG	240	2, 3	70–225	65 K	65 K	—	—	—	—
QJ ⁶	240	2, 3	70–225	100 K	100 K	—	—	—	—
JD	600	2, 3	150–250	25 K	25 K	18 K	14 K	20 K	20 K
JG	600	2, 3	150–250	65 K	65 K	35 K	18 K	20 K	20 K
JJ	600	2, 3	150–250	100 K	100 K	65 K	25 K	20 K	20 K
JL	600	2, 3	150–250	125 K	125 K	100 K	50 K	20 K	20 K
JR	600	2, 3	150–250	200 K	200 K	200 K	100 K	—	—
LA	600	2, 3	125–400	42 K	42 K	30 K	22 K	10 K	10 K
LH ⁴	600	2, 3	125–400	65 K	65 K	35 K	25 K	—	50 K
LD	600	2, 3	250–600	25 K	25 K	18 K	14 K	—	—
LG	600	2, 3	250–600	65 K	65 K	35 K	18 K	—	20 K
LJ	600	2, 3	250–600	100 K	100 K	65 K	25 K	—	—
LL	600	2, 3	250–600	125 K	125 K	100 K	50 K	—	20 K
LR	600	2, 3	250–600	200 K	200 K	200 K	100 K	—	—
MG	600	2, 3	300–800	65 K	65 K	35 K	18 K	—	—
MJ	600	2, 3	300–800	100 K	100 K	65 K	25 K	—	—
PG	600	2, 3	600–1200	65 K	65 K	35 K	18 K	—	—

4. Separate UL rating available for 240 V and 480 V grounded B phase systems. Circuit breakers must be ordered with 5861 suffix.
 5. 277 Vac rated.
 6. QJ 3-pole is rated 100 KA@208Y/120 Vac.

Circuit Breaker Frame Type	Maximum Voltage Rating	Number of Poles	Cont. Ampere Rating	UL/CSA Interrupting Rating—RMS Amperes (Symmetrical)					
				AC Volts, 50/60 Hz				DC Volts	
				120	240	480	600	125	250
PJ	600	2, 3	600–1200	100 K	100 K	65 K	25 K	—	—
PK ⁷	600	2, 3	600–1200	65 K	65 K	50 K	50 K	—	—
PL	480	2, 3	600–1200	125 K	125 K	100 K	25 K	—	—
RG	600	2, 3	1000–1200	65 K	65 K	35 K	18 K	—	—
RJ	600	2, 3	1000–1200	100 K	100 K	65 K	25 K	—	—
RK ⁷	600	2, 3	1000–1200	65 K	65 K	65 K	65 K	—	—
RL	600	2, 3	1000–1200	125 K	125 K	100 K	50 K	—	—

NOTE: 15 and 20 A are Switching Duty rated (SWD).

NOTE: FG and FJ 600Y/347 Vac @ 15–30 A only.

Circuit Breaker Terminal Data

Circuit Breaker	Frame Size	Ampere Rating	Terminal Lug Wire Size
FA	100 A	15–30	#14-#4 Cu or #12-#4 Al
FA	100 A	35–100	#14-1/0 Cu or #12-1/0 Al
FH	100 A	15–30	#14-#4 Cu or #12-#4 Al
FH	100 A	35–100	#14-1/0 Cu or #12-1/0 Al
BD, BG, BJ	125 A	15–125	#14-2/0 Al/Cu
BK	125 A	15–30	#14-2/0 Al/Cu
HD, HG, HJ, HL, HR	150 A	15–150	#14-3/0 Al/Cu
QB, QB, QG, QJ	225 A	70–225	#4-300 kcmil Al/Cu
JD, JG, JJ, JL	250 A	150–175	#4/0 Al/Cu
JD, JG, JJ, JL, JR	250 A	200–250	#3/0-350 kcmil Al/Cu
LA, LH	400 A	125–400	(1) #1-600 kcmil or (2) #1-250 kcmil Al/Cu
LD, LG, LJ, LL, LR	400 A	250	(1) #2-600 kcmil CU or (1) #2-500 kcmil AL
LD, LG, LJ, LL, LR	600 A	400–600	(2) #2-500kcmil AL/CU
MG, MJ	800 A	300–800	(3) 3/0-500 kcmil Al/Cu
PG, PJ, PK ⁸ , PL	1200 A	250–800	(3) 3/0-500 kcmil Al/Cu
PG, PJ, PK ⁸ , PL	1200 A	1000–1200	(4) 3/0-500 kcmil Al/Cu
RG, RJ, RK ⁸ , RL	1200 A	1000–1200	(4) 3/0-600 kcmil Al/Cu

NOTE: Lugs are rated for 75°C wire, except FA (15–30 A) and FI (20–30 A), which are rated for 60/75°C. Torque values are listed on the circuit breaker faceplate tables.

7. Canada Only.
8. Canada only.

Circuit Breaker Accessories

- Shunt trip
- Undervoltage trip
- Alarm switch
- Auxiliary contacts
- Ground-fault shunt trip

NOTE: All accessories, except for the Ground-fault shunt trip are fieldinstallable for LA, LH circuit breakers.

For detailed information on circuit breakers and accessories, refer to the Digest.

Circuit Breaker	Class
HD, HG, HJ, HL	611
QB, QD, QG, QJ	734
JD, JG, JJ, JL	611
LA, LH	660
MG, MJ	612
PG, PJ, PK ⁹ , PL	612
RG, RJ, RK ⁹ , RL	612

Plug-On Lugs Terminal Data

Plug-On Lugs



Amperage Rating	Frame Size	Catalog No.	Terminal Lug Wire Size
250 A	250 A	SL250	(1) #4-300 kcmil Al/Cu
400 A	400 A	SL400	(1) #1-600 kcmil Al/Cu or (2) #1-250 kcmil Al/Cu
800 A	800 A	SL800M5	(3) 3/0 AWG-500 kcmil
1200 A	1200 A	SL1200P5	(4) 3/0 AWG-500 kcmil
1200 A	1200 A	SL1200P6	(3) 350-600 kcmil
1200 A	1200 A	SL1200P7	(3) 3/0 AWG-750 kcmil (750 kcmil: Compact Al only)
1200 A ¹⁰	1200 A	S33930	(4) 3/0-600 kcmil Al/Cu

9. Canada only.

10. For 100% rated applications ("R" frame breakers).

Plug-On QO™ Distribution Panel (Catalog No. HQO306)

**QO with Visi-Trip™ Indicator
1-, 2-, and 3-Pole**



- Six-pole, 240 Vac maximum
- Use with QO, QO-H, QO-VH, QH, and Qwik-Gard™ plug-on circuit breakers through 30 A. For detailed information, refer to DP Catalog Class 730 and 910.
- Mounts in all I-Line panelboards.

QO Distribution Panel Branch Circuit Breakers

Qwik-Gard Circuit Breaker with Ground Fault Circuit Interrupter



Distribution Channel Type	Number of Poles & Amperages
10 k AIR, QO	1-Pole 10–30 A
	2-Pole 10–30 A
	3-Pole 10–30 A
10 k AIR, QO-GFI	1-Pole 15–30 A ¹¹
	2-Pole 15–30 A ¹¹
22 k AIR, QO-VH	1-Pole 15–30 A
	2-Pole 15–30 A
	3-Pole 15–30 A
22 k AIR, QO-VHGF1	1-Pole 15–30 A ¹¹
65 k AIR, QH	1-Pole 15–30 A
	2-Pole 15–30 A
	3-Pole 15–30 A

11. Maximum of three GFI-suffix circuit breakers can be installed.

Circuit Breaker Types

BD, BG, BJ, BK
1-, 2-, and 3-Pole; 15–125 A
(BK is 15–30 A)



QB, QD, QG, QJ
2- and 3-Pole; 70–225 A



HD, HG, HJ, HL
2- and 3-Pole; 15–150 A



JD, JG, JJ, JL
2- and 3-Pole; 150–250 A



MG, MJ
2- and 3-Pole; 300–800 A



PG, PJ, PK, PL
2- and 3-Pole; 250–1200 A



RG, RJ, RK, RL
2- and 3-Pole; 1000–1200 A



Mains Ampere Rating	Main Lugs		Main Circuit Breaker	
	Actual Lug Size	Cable Size Per UL/CSA Wire Bending Space	Actual Lug Size	Cable Size Per UL/CSA Wire Bending Space
Mechanical Lug Sizes				
100	—	—	(1) #14-1/0 Al/Cu	(1) #14-#1 Al/Cu
225	(1) #6-300 kcmil Al/Cu	(1) #6-300 kcmil Al/Cu	(1) #4-300 kcmil Al/Cu	(1) #4-300 kcmil Al/Cu
400	(2) #2-600 kcmil Al/Cu	(1) #2-600 kcmil Cu or (2) #2-500 kcmil Al/Cu	(1) #1-600 kcmil Al/Cu (2) #1-250 kcmil Al/Cu	(1) #1-600 kcmil Cu or (2) #1-250 kcmil Al/Cu
600	(2) #2-600 kcmil Al/Cu	(2) #2-500 kcmil Al/Cu	(3) 3/0-500 kcmil Al/Cu	(3) 3/0-500 kcmil Al/Cu
800	(4) 3/0-750 kcmil Al/Cu	(3) 3/0-500 kcmil Al/Cu	(4) 3/0-500 kcmil Al/Cu	(3) 3/0-500 kcmil Al/Cu
1200	(4) 3/0-750 kcmil Al/Cu	(4) 3/0-500 kcmil Al/Cu	(4) 3/0-600 kcmil Al/Cu	(4) 3/0-500 kcmil Al/Cu
100	—	—	(1) #8-1/0 Al/Cu	(1) #8-#1 Al/Cu
VCEL Lug Sizes¹²				
225	(1) #4-300 kcmil Al/Cu	(1) #4-300 kcmil Al/Cu	(1) #4-300 kcmil Al/Cu	(1) #4-300 kcmil Al/Cu
400	(1) 2/0-500 kcmil Al/Cu or (1) 500-750 kcmil Al or (2) #4-300 kcmil Al/Cu	(1) 2/0-500 kcmil Al/Cu or (1) 500-750 kcmil Al or (2) #4-250 kcmil Al/Cu	(1) 500 kcmil Cu or (1) 500-750 kcmil Al	(1) 500 kcmil Cu or (1) 500-750 kcmil Al
600	(2) 2/0-500 kcmil Al/Cu	(2) 2/0-500 kcmil Al/Cu	(2) 2/0-500 kcmil Al/Cu	(2) 2/0-500 kcmil Al/Cu
800	(3) 2/0-500 kcmil Al/Cu	(3) 2/0-500 kcmil Al/Cu	(2) 500 kcmil Cu or (2) 500-750 kcmil Al	(2) 500 kcmil Cu or (2) 500-750 kcmil Al
1200	(4) 500 kcmil Cu or (4) 500-750 kcmil Al	(4) 500 kcmil Cu or (4) 600 kcmil Al	—	—

NOTE: All lugs are suitable for 75°C wire. Torque values are included on the neutral diagram.

12. Compression lugs vary depending on interior type used; contact your local Schneider Electric sales office for assistance.

Dimensions

Type HCJ—800 A Maximum Main Lugs

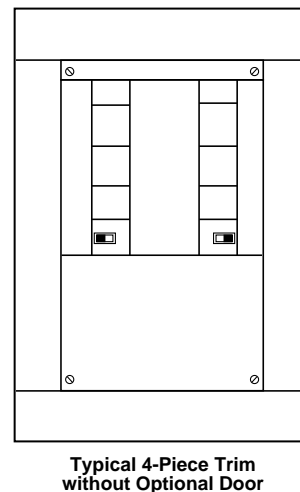
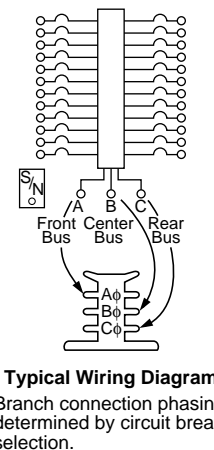
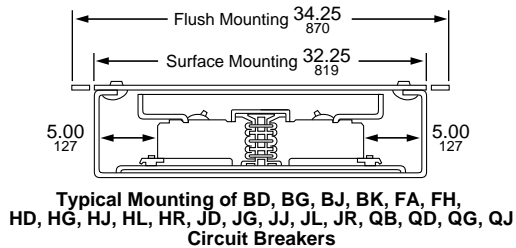
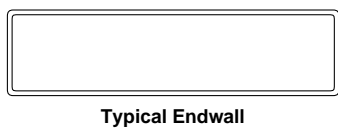
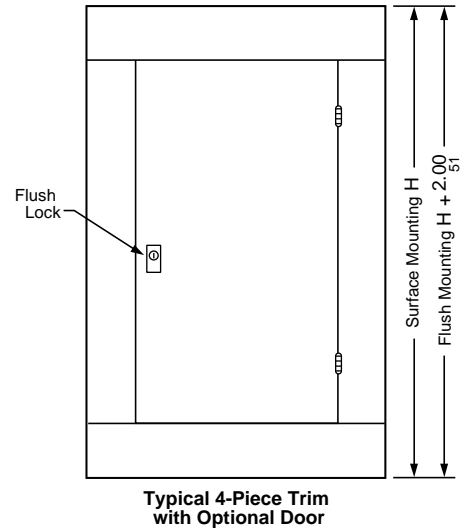
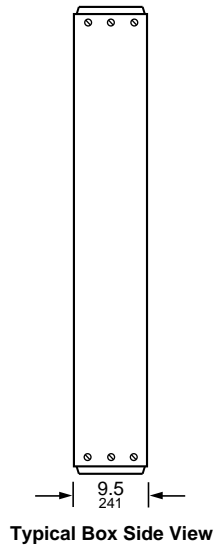
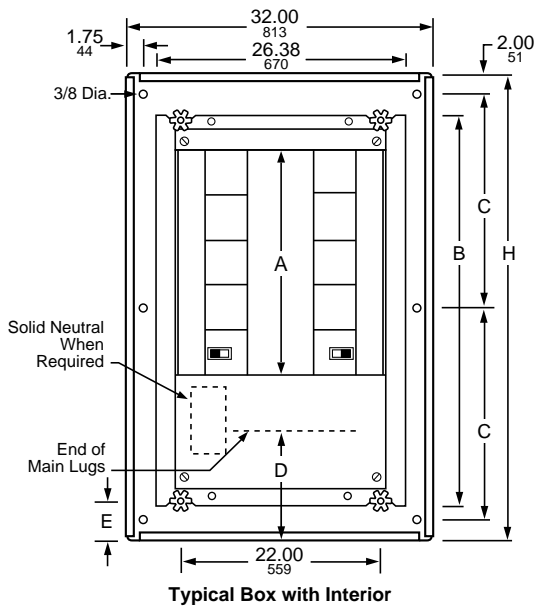

Main Lugs Ampere Rating	Catalog Number										D		E			
	Interior	Box	4-Piece Trim without Door ¹³	4-Piece Trim with Door ¹³	H		A		B		C		in.	mm		
					in.	mm	in.	mm	in.	mm	in.	mm				
400	HCJ1448414	HC3248DB9	HC3248T()	HC3248T()D	48	1219	13.5	343	30	762	21.85	555	14.9	378	9.3	236
	HCJ14484CU															
	HCJ23734	HC3273DB9	HC3273T()	HC3273T()D ¹⁵	73	1854	31.5	800	48	1219	22.9	582	18.4	467	12.8	325
	HCJ3273414															
	HCJ32734CU															
	HCJ50914															
HCJ1448614	HC3248DB9	HC3248T()	HC3248T()D	48	1219	13.5	343	30	762	21.85	555	14.9	378	9.3	236	
HCJ14486CU																
600	HCJ23736	HC3273DB9	HC3273T()	HC3273T()D ¹⁵	73	1854	31.5	800	48	1219	22.9	582	18.4	467	12.8	325
	HCJ3273614															
	HCJ32736CU															
	HCJ50916															
	HCJ14488	HC3248DB9	HC3248T()	HC3248T()D	48	1219	13.5	343	30	762	21.85	555	14.9	378	9.3	236
	HCJ23738															
800	HCJ32738	HC3273DB9	HC3273T()	HC3273T()D ¹⁵	73	1854	31.5	800	48	1219	22.9	582	18.4	467	12.8	325
	HCJ32738															
	HCJ50918	HC3291DB9	HC3291T()	HC3291T()D ¹⁵	91	2311	49.5	1257	66	1676	28.9	734	18.4	467	12.8	325

13. Replace parentheses with "F" for flush or "S" for surface.
 14. Add Cu to suffix for copper bus.
 15. Two flush locks are supplied.

Type HCJ 400 A Maximum Main Circuit Breaker

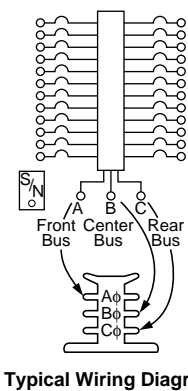
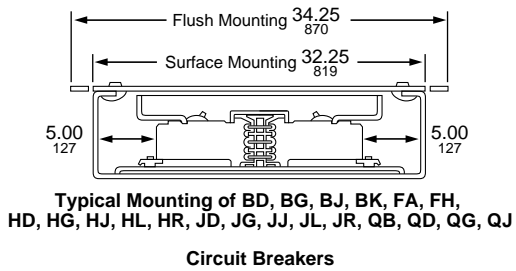
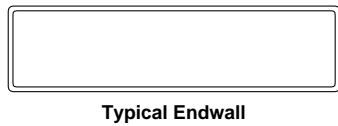
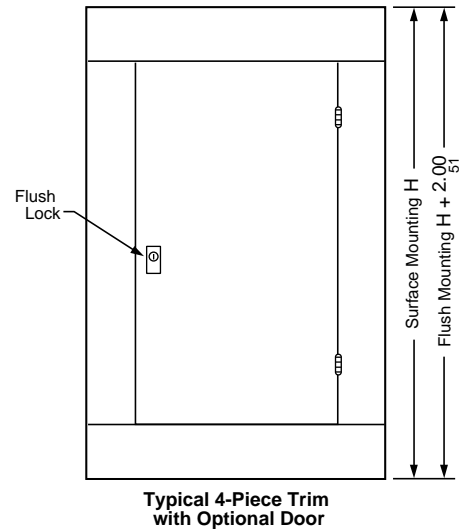
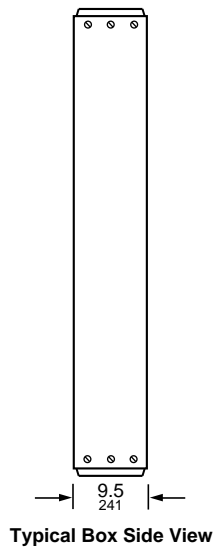
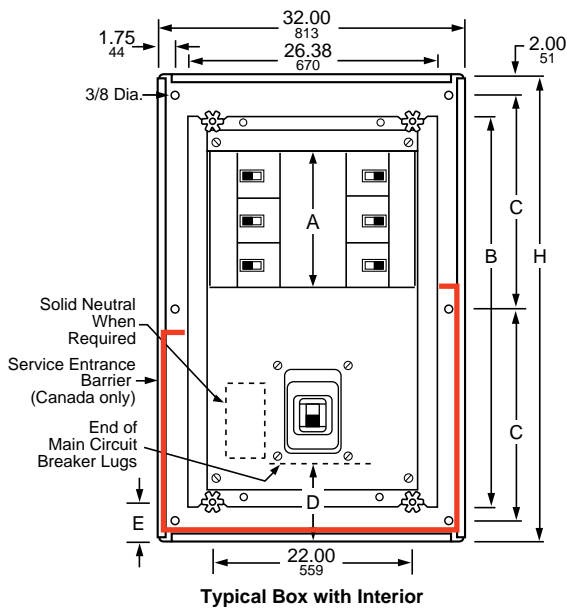

Branch connection phasing is determined by circuit breaker selection.

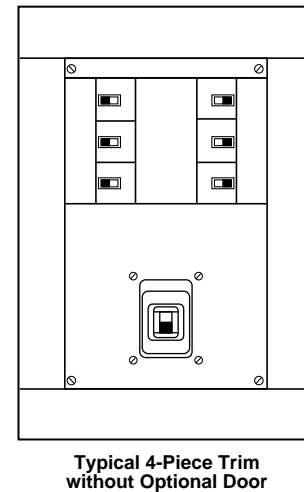

Main Circuit Break- er Am- pere Rating	Catalog Number				H		A		B		C		D		E	
	Interior	Box	4-Piece Trim without Door ¹⁶	4-Piece Trim with Door ¹⁶	in.	mm	in.	mm	in.	mm	in.	mm	in.	mm	in.	mm
400	HCJ14734M	HC3273DB9	HCJ73T()	HCJ73T(D)	64	1626	73	1854	13.5	343	22.9	582	16.96	431	12.8	325
400	HCJ23734M	HC3273DB9	HCJ73T()	HCJ73T() ¹⁷	73	1854	73	1854	22.5	572	22.9	582	16.96	431	12.8	325
400	HCJ41914M ¹⁸	HC3291DB9	HCJ91T()	HCJ91T(D) ¹⁷	91	2311	91	2311	40.5	1029	28.9	734	16.96	431	12.8	325
400	HCJ41914M- CU	HC3291DB9	HCJ91T()	HCJ91T(D)	91	2311	91	2311	40.5	1029	28.9	734	16.96	431	12.8	325

16. Replace parentheses with "F" for flush or "S" for surface.
 17. Two flush locks are supplied.
 18. Add Cu to suffix for copper bus.

Type HCJ—800 A Maximum Main Circuit Breaker

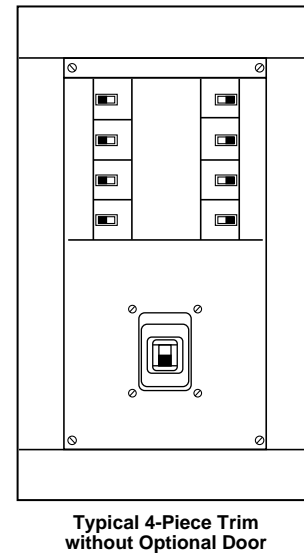
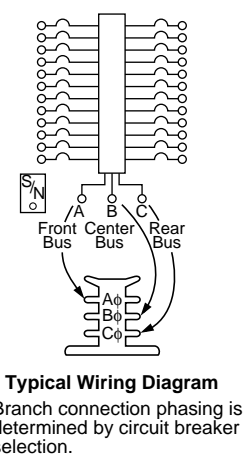
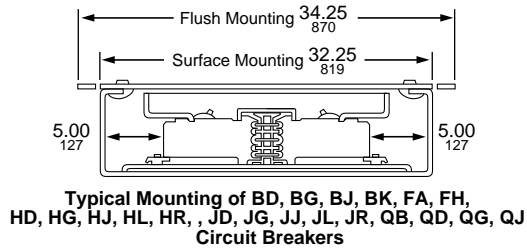
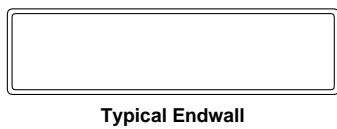
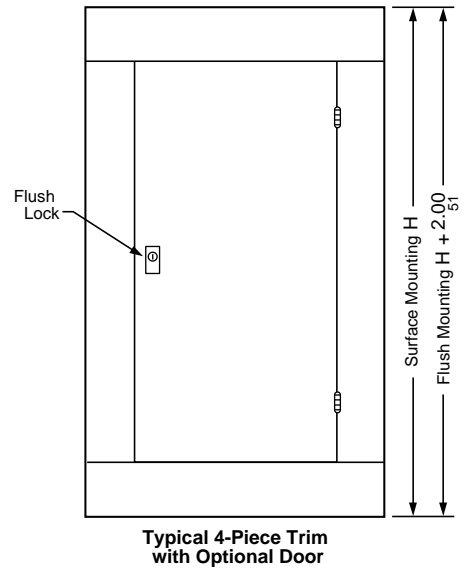
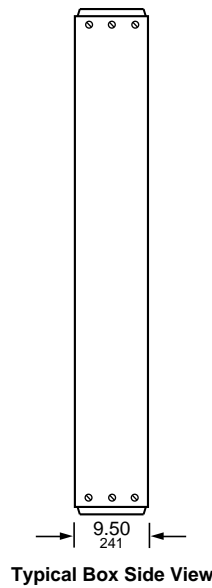
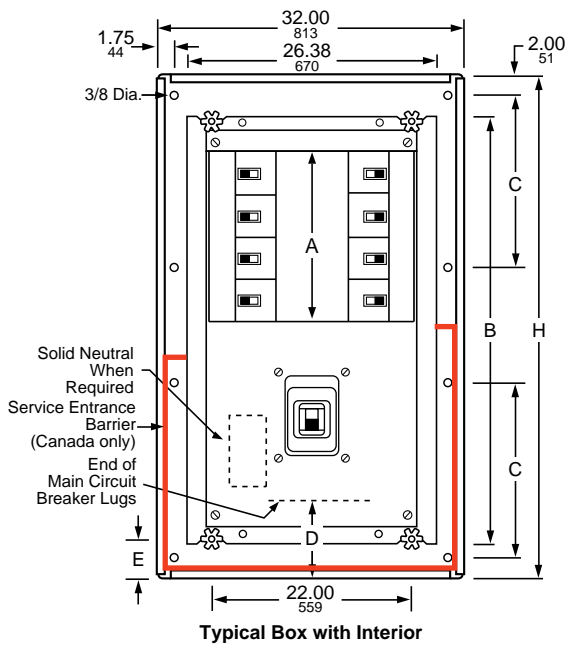

Main Circuit Breaker Ampere Rating	Catalog Number				H		A		B		C		D		E	
	Interior	Box	4-Piece Trim without Door ¹⁹	4-Piece Trim with Door ^{19, 20}	in.	mm	in.	mm	in.	mm	in.	mm	in.	mm	in.	mm
600	HCJ18736MP	HC3273DB9	HCM73T()	HCM73T(D)	73	1854	18	457	48	1219	22.9	582	18.68	474	12.8	325
	HCJ36916MP	HC3291DB9	HCM91T()	HCM91T(D)	91	2311	36	914	66	1676	28.9	734	18.68	474	12.8	325
800	HCJ18738MP	HC3273DB9	HCM73T()	HCM73T(D)	73	1854	18	457	48	1219	22.9	582	18.68	474	12.8	325
	HC36918MP	HC3291DB9	HCM91T()	HCM91T(D)	91	2311	36	914	66	1676	28.9	734	18.68	474	12.8	325

19. Replace parentheses with "F" for flush or "S" for surface.
 20. Two flush locks are supplied.

Type HCP—800 A Maximum Main Lugs

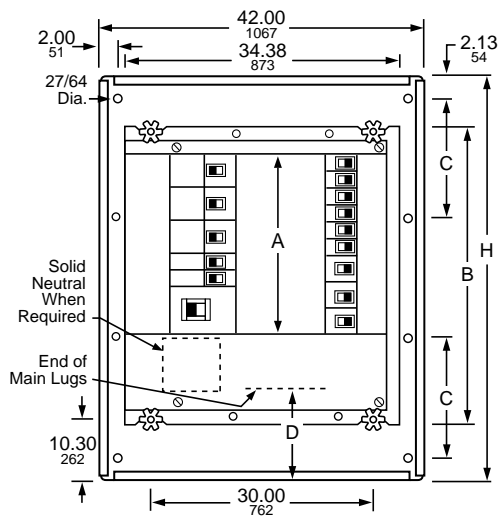

Typical Box with Interior

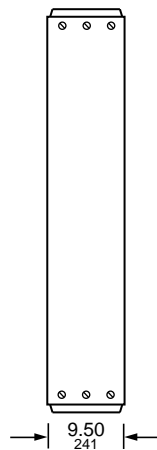

Typical Box Side View

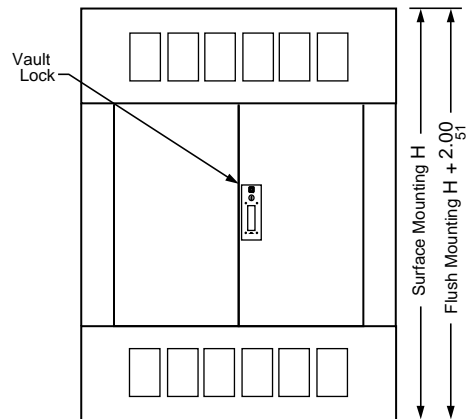

Typical 4-Piece Trim with Optional Door

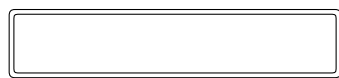

Typical Endwall

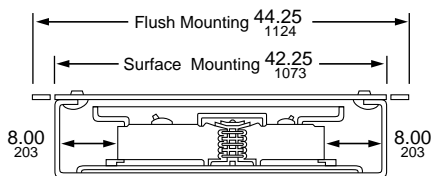

Typical Mounting of BD, BG, BJ, BK, FA, FH, HD, HG, HJ, HL, JD, JG, JJ, JL, LA, LD, LG, LJ, LL, LR, MG, MJ
 Typical Wiring Diagram
 PG, PJ, PK, PL, QB, QD, QG, QJ
 Circuit Breakers

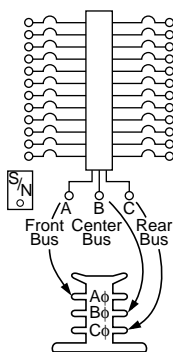

Branch connection phasing is determined by circuit breaker selection.

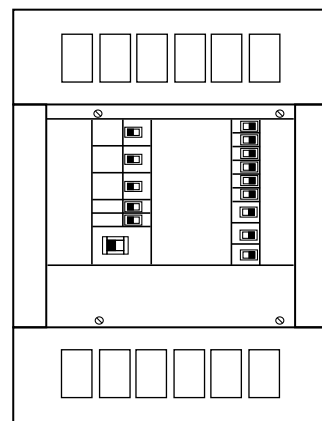

Typical 4-Piece Trim without Optional Door

Main Lugs Ampere Rating	Catalog Number										H		A		B		C		D	
	Interior	Box	4-Piece Trim without Door ²¹	4-Piece Trim with Door ²¹	in.		mm		in.		mm		in.		mm		in.		mm	
					in.	mm	in.	mm	in.	mm	in.	mm	in.	mm	in.	mm				
400	HCP14504	HC4250DB	HCW50T()	HCW50T()D	50	1270	13.5	343	30	762	22.85	580	17.5	445						
	HCP23594	HC4259DB	HCW59T()	HCW59T()D	59	1499	22.5	572	39	991	27.35	695	17.5	445						
	HCP32684	HC4268DB	HCW68T()	HCW68T()D	68	1727	31.5	800	48	1219	31.85	809	17.5	445						
	HCP50864	HC4286DB	HCW86T()	HCW86T()D	86	2184	49.5	1257	66	1676	27.23	692	17.5	445						
	HCP14506	HC4250DB	HCW50T()	HCW50T()D	50	1270	13.5	343	30	762	22.85	580	17.5	445						
	HCP23596	HC4259DB	HCW59T()	HCW59T()D	59	1499	22.5	572	39	991	27.35	695	17.5	445						
600	HCP32686	HC4268DB	HCW68T()	HCW68T()D	68	1727	31.5	800	48	1219	31.85	809	17.5	445						
	HCP50866	HC4286DB	HCW86T()	HCW86T()D	86	2184	49.5	1257	66	1676	27.23	692	17.5	445						
	HCP14508	HC4250DB	HCW50T()	HCW50T()D	50	1270	13.5	343	30	762	22.85	580	16.32	415						
	HCP23598	HC4259DB	HCW59T()	HCW59T()D	59	1499	22.5	572	39	991	27.35	695	16.32	415						
800	HCP32688	HC4268DB	HCW68T()	HCW68T()D	68	1727	31.5	800	48	1219	31.85	809	16.32	415						
	HCP50868	HC4286DB	HCW86T()	HCW86T()D	86	2184	49.5	1257	66	1676	27.23	692	16.32	415						

21. Replace parentheses with "F" for flush or "S" for surface.

Type HCP—1200 A Maximum Main Lugs

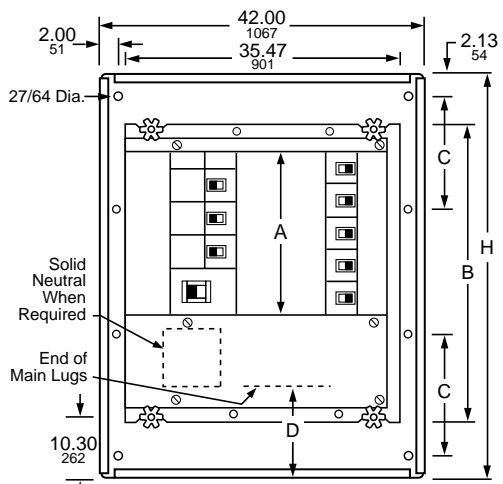

Typical Box with Interior

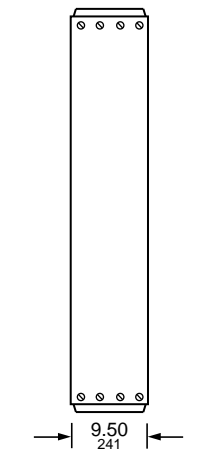

Typical Box Side View

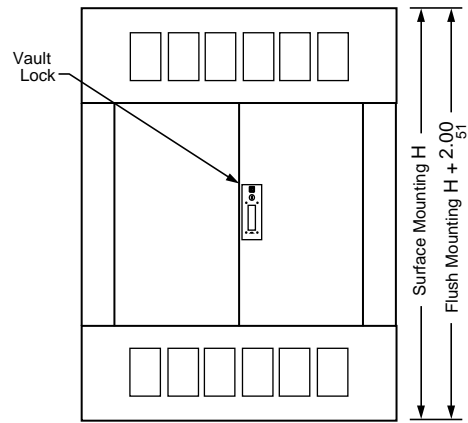

Typical 4-Piece Trim with Optional Door

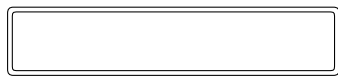

Typical Endwall

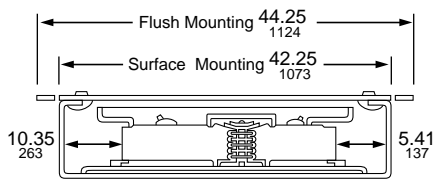

Typical Mounting of BD, BG, BJ, BK, FA, FH, HD, HG, HJ, HL, JD, JG, JJ, JL, LA, LD, LG, LJ, LL, LR, MG, MJ, PG, PJ, PK, PL, QB, QD, QG, QJ Circuit Breakers

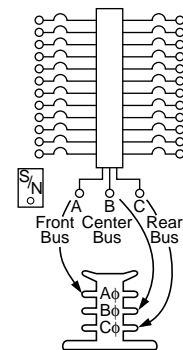

Typical Wiring Diagram
Branch connection phasing is determined by circuit breaker selection.

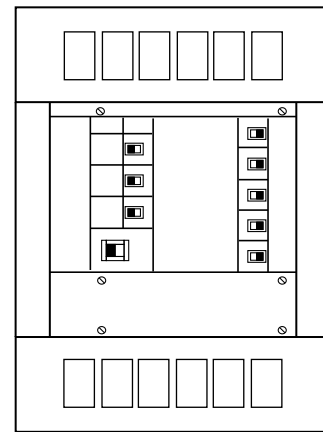

Typical 4-Piece Trim without Optional Door

Main Lugs Ampere Rating	Catalog Number						H		A		B		C		D	
	Interior	Box	4-Piece Trim without Door ²²	4-Piece Trim with Door ²²	in.	mm	in.	mm	in.	mm	in.	mm	in.	mm	in.	mm
1200	HCP145012N	HC4250DB	HCW50T()	HCW50T()D	50	1270	13.5	343	30	762	22.85	580	16.32	415		
	HCP235912N	HC4259DB	HCW59T()	HCW59T()D	59	1499	22.5	572	39	991	27.23	692	16.32	415		
	HCP326812N	HC4268DB	HCW68T()	HCW68T()D	68	1727	31.5	800	48	1219	31.85	809	16.32	415		
	HCP508612N	HC4286DB	HCW86T()	HCW86T()D	86	2184	49.5	1257	66	1676	27.23	692	16.32	415		

22. Replace parentheses with "F" for flush or "S" for surface.

Type HCP—800 A Maximum Main Circuit Breaker

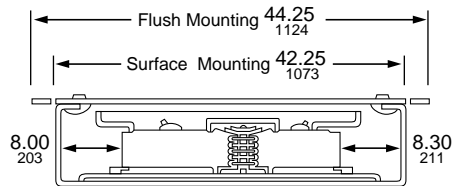
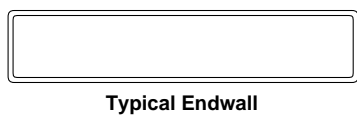
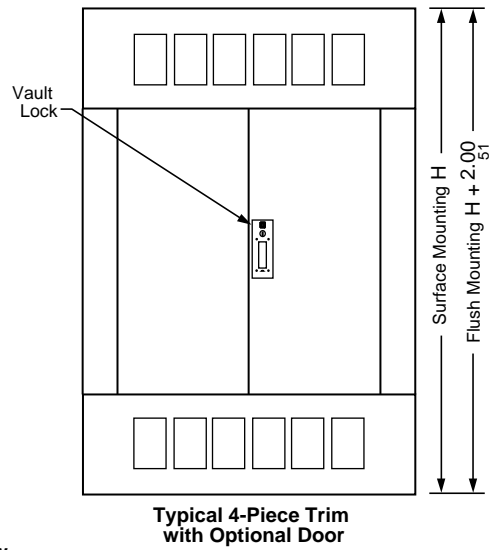
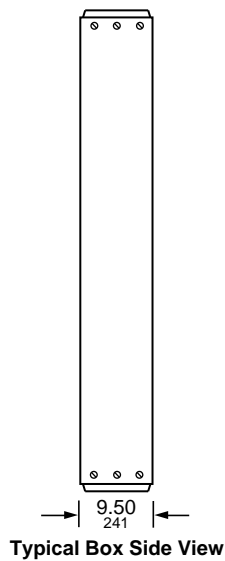
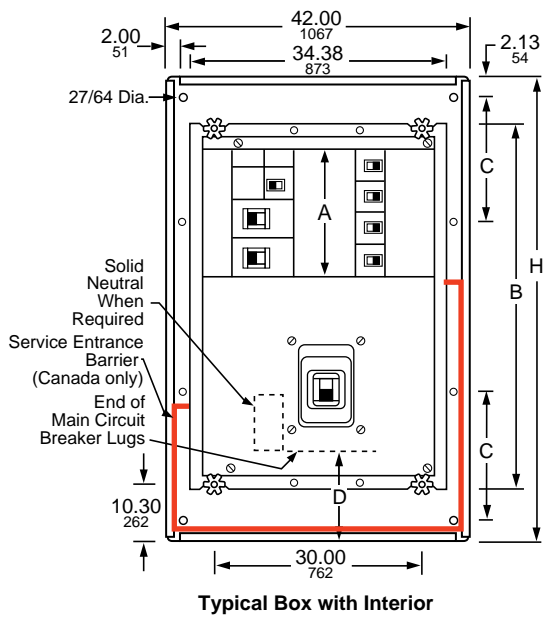

Typical Mounting of BD, BG, BJ, BK, FA, FH, HD, HG, HJ, HL, JD, JG, JJ, JL, LA, LD, LG, LJ, LL, LR, MG, MJ, PG, PJ, PK, PL, QB, QD, QG, QJ Circuit Breakers

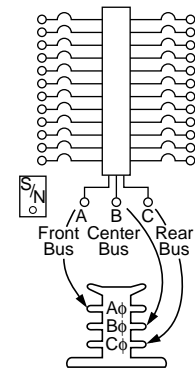

Branch connection phasing is determined by circuit breaker selection.

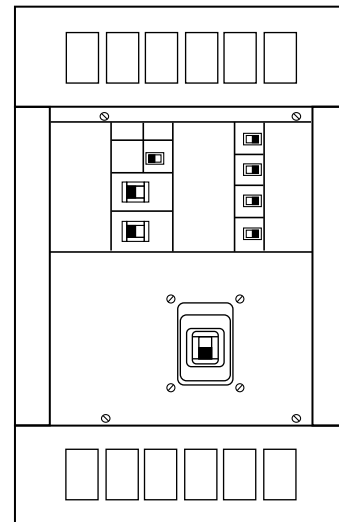

Main Circuit Breaker Ampere Rating	Catalog Number				H		A		B		C		D	
	Interior	Box	4-Piece Trim without Door ²³	4-Piece Trim with Door ²³	in.	mm	in.	mm	in.	mm	in.	mm	in.	mm
600	HCP18686M	HC4268DB	HCW68T()	HCW68T(D)	68	1727	18	457	48	1219	31.85	809	18.68	474
	HCP36866M	HC4286DB	HCW86T()	HCW86T(D)	86	2184	36	914	66	1676	27.23	692	18.68	474
800	HCP18688M	HC4268DB	HCW68T()	HCW68T(D)	68	1727	18	457	48	1219	31.85	809	18.68	474
	HCP36868M	HC4286DB	HCW86T()	HCW86T(D)	86	2184	36	914	66	1676	27.23	692	18.68	474

23. Replace parentheses with "F" for flush or "S" for surface.

Type HCP-SU—800 A Maximum Main Circuit Breaker

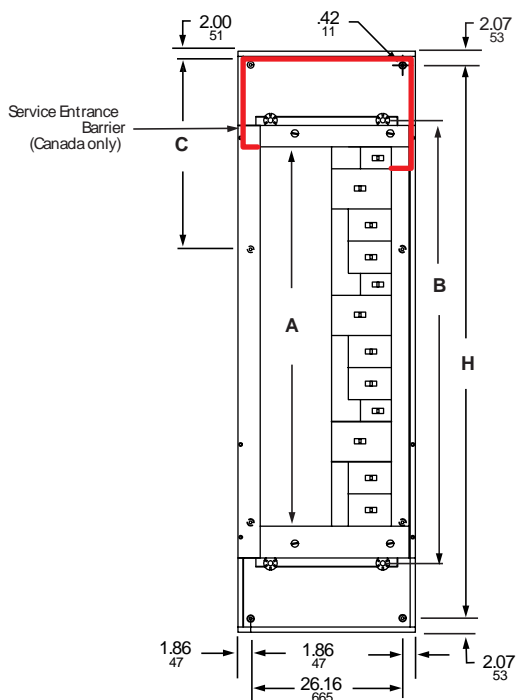

Typical Box with Interior

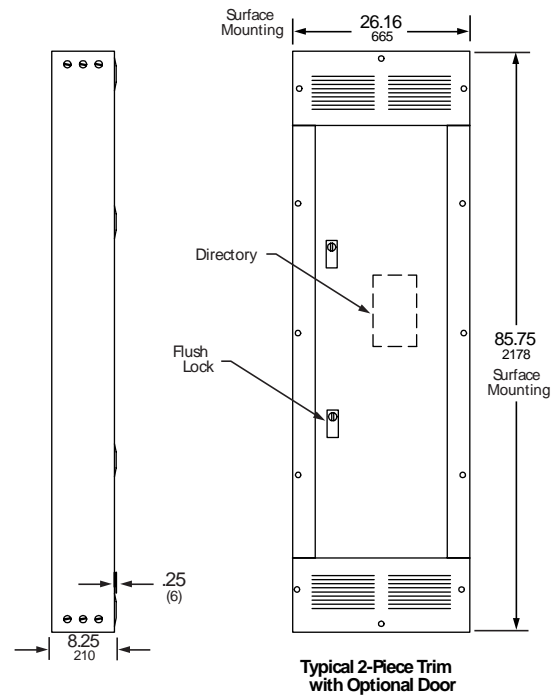

Typical Box Side View

Typical 2-Piece Trim with Optional Door

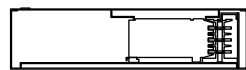

Typical Mounting of BD, BG, BJ, BK, FA, FH, HD, HG, HJ, HL, JD, JG, JJ, JL, LA, LD, LG, LJ, LL, LR, MG, MJ, PG, PJ, PK, PL, QB, QD, QG, QJ Circuit Breakers

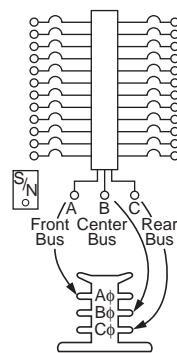

Branch connection phasing is determined by circuit breaker selection.

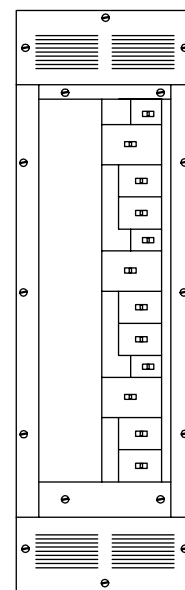

Typical 2-Piece Trim without Optional Door

Main Circuit Breaker Ampere Rating	Catalog Number			H		A		B		C		
	Interior	Box	2-Piece Trim without Door ^{24, 25}	2-Piece Trim with Door ^{24, 25}	in.	mm	in.	mm	in.	mm	in.	
800	HCP54868SU	HC2686DB	HC2686T()	HC2686T(J)D	86	2184	54	1372	65.4	1661	27.23	692

24. Replace parentheses with "F" for flush or "S" for surface.
 25. Flush trims are 4-piece.

Type HCR-U—1200 A Main Lugs or Main Circuit Breaker

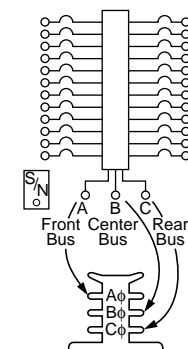
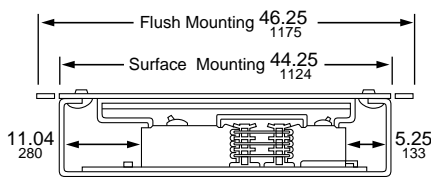
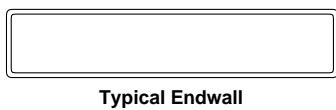
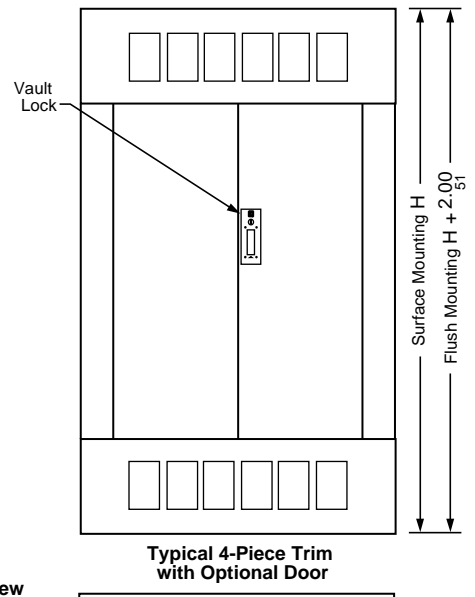
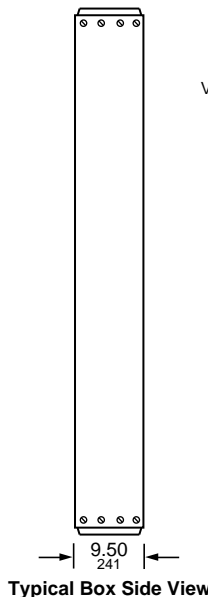
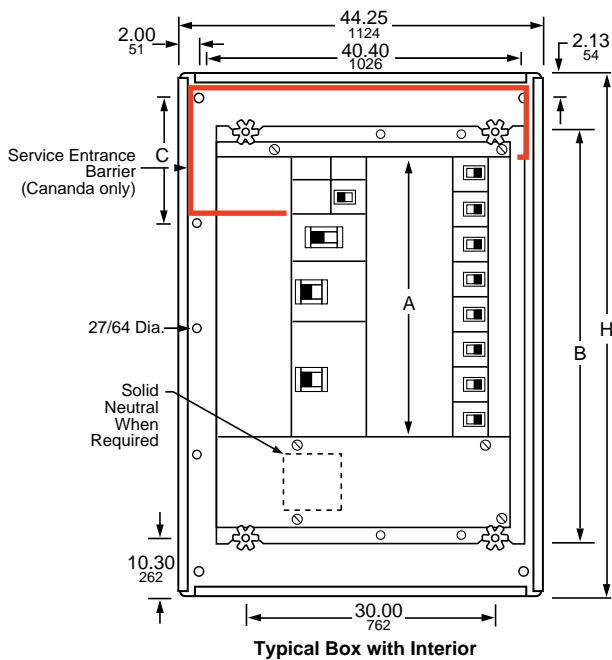

Branch connection phasing is determined by circuit breaker selection.

Back-fed PG, PJ, PL, RG, RJ, and RL Main Circuit Breaker or Main Lugs Kit S33930 (see Note.)

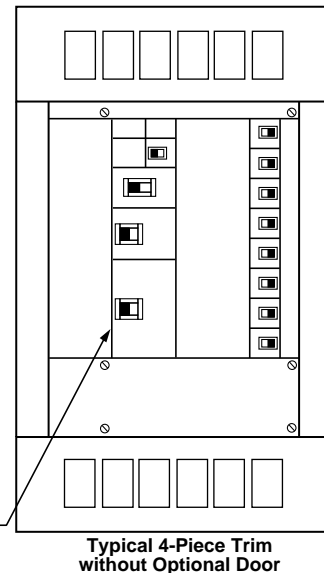

Main Lugs or Main Circuit Breaker Ampere Rating	Catalog Number				H		A		B		C	
	Interior	Box	4-Piece Trim without Door ²⁶	4-Piece Trim with Door ²⁶	in.	mm	in.	mm	in.	mm	in.	mm
1200	HCR548612U	HC4486DB	HCR86T()	HCR86T()D	86	2184	54	1372	65.1	1654	18	457

NOTE: The back-fed RG, RJ, and RL Main Circuit Breaker or Main Lugs Kit takes up 15 in. (381 mm) of mounting space, leaving 93 in. (2362 mm) of branch circuit breaker mounting space. The back-fed PG, PJ, PL Main Circuit Breaker takes up 9 in. (229 mm) of mounting spaces, leaving 99 in. (2515 mm) of branch circuit breaker mounting space.

26. Replace parentheses with "F" for flush or "S" for surface.

Schneider Electric
1415 S. Roselle Road
Palatine, IL 60067
USA

888-778-2733

www.se.com

As standards, specifications, and design change from time to time,
please ask for confirmation of the information given in this publication.

© 1998 – 2020 Schneider Electric. All rights reserved.

2110CT9701