

Selection Guide

Applications

Schneider Electric NSR Forta M400A-VB, M800A-VB, and M1500A-VB Screw Mount series linear actuators mount directly onto 1/2" to 2" VB-7xxx series two-way and three-way globe valve bodies. Schneider Electric NSR Forta M400A, M800A and M1500 A U-Bolt series linear actuators mount to a valve with additional linkage. Applications include chilled or hot water and steam. Field selectable input signals include reverse and direct acting, floating or proportional 0-10 Vdc, 2-10 Vdc, or 4-20 mAdc, and proportional sequencing input signal ranges¹.

Applicable Literature

- Schneider Electric Forta M400A (VB) Series, M800A (VB) Series, and M1500A (VB) Series Installation Instructions, (F-27599)
- AV-821 Installation Instructions (U-Bolt style only), F-27701
- Schneider Electric Valves Catalog, F-27414
- CA-28 Control Valve Sizing, F-13755

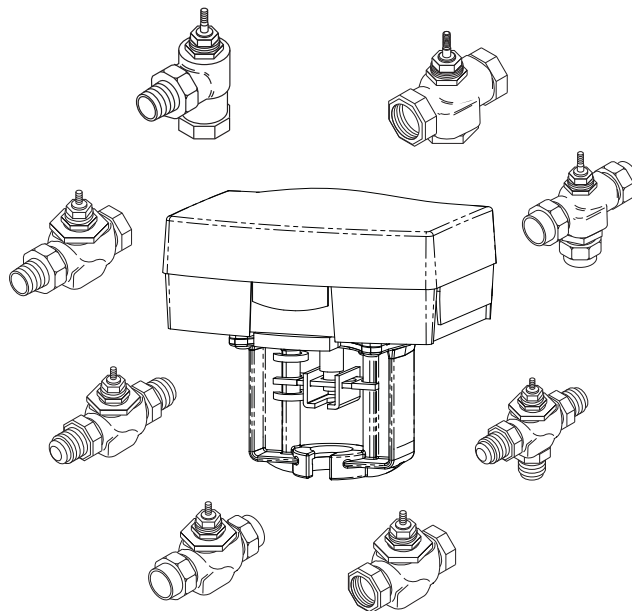

Selection Guide Contents

Applications.....	page 1
Valve and Actuator Selection Procedure	page 2
Schneider Electric VB-72xx Series Two-Way Valve Bodies ...	page 3
Schneider Electric VB-73xx Series Three-Way Valve Bodies.	page 4
Schneider Electric NSR Forta Actuator Model Chart	page 5
Ambient Temperature Restrictions.....	page 5
Valve/Actuator Close-off Pressures	page 5
Factory Valve and Actuator Assemblies	page 6
NSR Forta Actuator Dimensions	page 7
Two-Way Valve/Actuator Assembly Dimensions	page 8
Three-Way Valve/Actuator Assembly Dimensions.....	page 9

¹. 0-5 Vdc, 5-10 Vdc, 2-6 Vdc, and 6-10 Vdc also available

Valve and Actuator Selection Procedure

1. Determine the required flow coefficient (Cv/kvs).

Using the required flow and pressure drop for the application (consult CA28, F-13755 if necessary), determine the required flow coefficient.

2. Determine valve body part number.

Select a two-way valve body from Table-1 or a three-way mixing or diverting valve body from Table-2 having the required flow coefficient, size, body pattern, end connection, and temperature/pressure ratings appropriate for the application.

3. Select the Forta Actuator

Using the required close-off pressure for the application, consult Table-5 and select a Forta actuator having sufficient close-off pressure on the valve body selected in Step 2. Additional Forta actuator specifications may be found in Table-3 or in the Forta Installation Instructions sheets shown in *Applicable Literature*.

4. Determine Assembly Part Number

If a complete valve and actuator assembly is required, consult Table-3 for the actuator code of the Forta actuator selected in Step 3. For the complete assembly part number:

- Change the valve body part number prefix from VB to VU.
- Insert the actuator code in the third field of the part number.
- Confirm the availability of the factory assembly by consulting Table-6 (two-way valves), Table-7 (three-way mixing valves), or Table-8 (three-way diverting valves).

Example:

- Valve body: VB-7213-0-4-4
- Actuator: M400A-VB (actuator code 674 from table 3)
- Complete assembly: VU-7213-674-4-4

Forta actuators are field configured for the desired control signal type and range plus the desired action. Consult the appropriate Forta Installation Instructions for further information (see *Applicable Literature, F-27599*).

Valve Body and Actuator Selection

Table-1 Schneider Electric VB-72xx Series Two-Way Valve Bodies

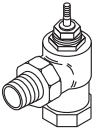
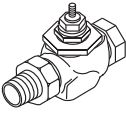
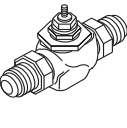
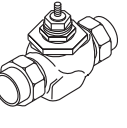
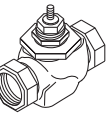
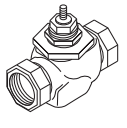
Two-Way Valves		Application: Chilled or Hot Water					Application: Hot Water or Steam	
								
		Union Angle	Union Straightway	SAE Flared	Union Sweat	NPT Threaded Rp Threaded	NPT Threaded	
Size		1/2" to 1-1/4"	1/2" to 1-1/4"	5/8" OD	1/2" to 2"	1/2" to 2" 15 to 50 mm	1/2" to 2"	
Valve Body Part Number, Stem Up Open		VB-7211-0-3-P	VB-7211-0-4-P	VB-7212-0-4-P	VB-7214-0-4-P	VB-7213-0-4-P VB-7215-0-4-P ^a	VB-7253-0-4-P	VB-7273-0-4-P
Valve Body Part Number, Stem Up Closed		—	VB-7221-0-4-P	VB-7222-0-4-P	VB-7224-0-4-P	VB-7223-0-4-P VB-7225-0-4-P ^a	VB-7263-0-4-P	VB-7283-0-4-P
Flow Type		Equal %					Modified Linear	
Material	Body	Bronze					Bronze	
	Seat	Bronze					Stainless Steel	
	Stem	Stainless Steel					Stainless Steel	
	Plug	Brass					Stainless Steel	
	Packing	Spring Loaded TFE/EPDM					Spring Loaded TFE	
	Disc	EPDM					Teflon	None
Pressure Class		ANSI 250 Up to 400°F (204°C) below 150°F (65°C)				ISO PN16		
Maximum Inlet Pressure, Steam		35 PSIG (241 kPa)					100 PSIG (690 kPa)	150 PSIG (1034 kPa)
Allowable Control Media Temperature		20°F to 281 °F (-7°C to 138°C)					20 to 340°F (-7 to 171°C)	20 to 400°F (-7 to 205°C)
Allowable Differential Pressure, Water^b		35 PSI (241 kPa) for Normal Life					35 PSIG (241 kPa)	35 PSIG (241 kPa)
Allowable Differential Pressure, Steam^b		20 PSI (138 kPa)					35 PSI (241 kPa)	50 PSI (345 kPa)
To Select a Port Code (P)								
P Code	Valve Size	Cv (kvs) Rating						
01	1/2" (15 mm)	0.4 (0.34)	0.4 (0.34)	0.4 (0.34)	0.4 (0.34)	0.4 (0.34)	0.4 (0.34)	0.4 (0.34)
02		1.3 (1.1)	1.3 (1.1)	1.3 (1.1)	1.3 (1.1)	1.3 (1.1)	1.3 (1.1)	1.3 (1.1)
03		2.2 (1.9)	2.2 (1.9)	2.2 (1.9)	2.2 (1.9)	2.2 (1.9)	2.2 (1.9)	2.2 (1.9)
04		5.0 (4.3)	4.4 (3.8)	4.4 (3.8)	4.4 (3.8)	4.4 (3.8)	4.4 (3.8)	4.4 (3.8)
05	3/4" (20 mm)	5.5 (4.7)	5.5 (4.7)	—	5.5 (4.7)	5.5 (4.7)	5.5 (4.7)	5.5 (4.7)
06		8.5 (7.4)	7.5 (6.5)	—	7.5 (6.5)	7.5 (6.5)	7.5 (6.5)	7.5 (6.5)
07	1" (25 mm)	14 (12)	10 (8.6)	—	10 (8.6)	10 (8.6)	10 (8.6)	10 (8.6)
08		16 (14)	14 (12)	—	14 (12)	14 (12)	12 (10.4)	12 (10.4)
09	1-1/4" (32 mm)	22 (19)	20 (17.3)	—	20 (17.3)	20 (17.3)	20 (17.3)	20 (17.3)
10	1-1/2" (40 mm)	—	—	—	28 (21.2)	28 (21.2)	28 (21.2)	28 (21.2)
11	2" (50 mm)	—	—	—	40 (34.6)	40 (34.6)	40 (34.6)	40 (34.6)

^a 15 to 50 mm valves with metric thread Rp 1/2 to Rp 2

^b Maximum recommended differential in full open position. Do not exceed recommended differential pressure (pressure drop) or integrity of parts may be affected.

Table-2 Schneider Electric VB-73xx Series Three-Way Valve Bodies

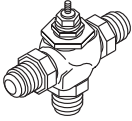
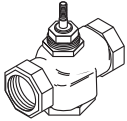
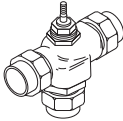
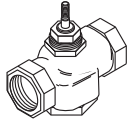
Three-Way Valves		Application: Chilled or Hot Water			
					
<ul style="list-style-type: none"> Mixing or Diverting 5/8" OD SAE Flared 1/2" to 2" NPT or Rp Threaded 1/2" to 2" Union Sweat 		SAE Flared	NPT Threaded Rp Threaded	Union Sweat	NPT Threaded
Size	5/8" OD	1/2" to 2" 15 to 50 mm	1/2" to 2"	1/2" to 2"	
Valve Body Part Number, Mixing^a	VB-7312-0-4-P	VB-7313-0-4-P VB-7315-0-4-P ^b	VB-7314-0-4-P	—	
Valve Body, Part Number Diverting^c	—	—	—	VB-7323-0-4-P	
Flow Type	Equal %				
Material	Body	Bronze			
	Seat	Bronze			
	Stem	Stainless Steel			
	Plug	Brass			
	Packing	Spring Loaded TFE/EPDM			
Disc	None				
Pressure Class	ANSI 250 Up to 400°F (204°C) below 150°F (65°C)		ISO PN16		
Allowable Control Media Temperature	20°F to 281°F (-7°C to 138°C)	20°F to 300°F (-7°C to 149°C)			
Allowable Differential Pressure, Water^d	35 PSI (241 kPa) for Normal Life				
To Select a Port Code (P)					
P Code	Valve Size	Cv (kvs) Rating			
02	1/2" (15 mm)	2.2 (1.9)	2.2 (1.9)	2.2 (1.9)	—
04		4.4 (3.8)	4.4 (3.8)	4.4 (3.8)	4.4 (3.8)
06	1" (25 mm)	—	7.5 (6.5)	7.5 (6.5)	7.5 (6.5)
08		—	14 (12)	14 (12)	15 (13)
09	1-1/4" (32 mm)	—	20 (17.3)	20 (17.3)	20 (17.3)
10	1-1/2" (40 mm)	—	28 (21.2)	28 (21.2)	28 (21.2)
11	2" (50 mm)	—	41 (36)	41 (36)	40 (34.6)

^a On VB-7313 and VB-7315 mixing valves, port AB is the common port (located on the side) and ports A and B are inlets. Flow is from B to AB when the valve stem is in up position (port A closed). Flow is from A to AB when valve stem is in down position (port B closed).

^b 15 to 50 mm valves with metric thread Rp 1/2 to Rp 2

^c On VB-7323 diverting valves, inlet port B is the common port (located on the bottom) and ports AB and B are outlets. When the valve stem is in the up position, flow is from B to AB (port A closed). When the valve stem is in the down position, flow is from port B to A (port AB closed).

^d Maximum recommended differential in full open position. Do not exceed recommended differential pressure (pressure drop) or integrity of parts may be affected.

Table-3 Schneider Electric NSR Forta Actuator Model Chart

Model	Actuator Code	Linkage Kit	Force, lbf (N)	Power	Running VA	Transformer Sizing VA	Floating Control ^a	Proportional Control ^a	Feedback	(2) SPDT Auxiliary Switches			
M400A ^c	— ^b	AV-821 ^c	90 (400)	24 Vac ±10% 50/60 Hz, or 20 to 29 Vdc	6	30 ^e	Yes	0-10 Vdc, 2-10 Vdc, or 4-20 mA _{dc} with 500 ohm resistor	2-10 Vdc	No			
M400A-VB	674	—								24 Vac 4A res			
M400A-S2 ^c	— ^b	AV-821 ^c								24 Vac 4A res			
M400A-S2-VB	— ^b	—											
M800A ^c	— ^b	AV-821 ^c	180 (800)		15	50 ^e				Yes	0-10 Vdc, 2-10 Vdc, or 4-20 mA _{dc} with 500 ohm resistor	2-10 Vdc	No
M800A-VB	680	—											24 Vac 4A res
M800A-S2 ^c	— ^b	AV-821 ^c											24 Vac 4A res
M800A-S2-VB	— ^b	—											
M1500A ^{cd}	— ^b	AV-821 ^c	337 (1500)		24	50 ^e							Yes
M1500A-VB ^d	686	—		24 Vac 4A res									
M1500A-S2 ^{cd}	— ^b	AV-821 ^c		24 Vac 4A res									
M1500A-S2-VB ^d	— ^b	—		24 Vac 4A res									

- ^a DIP switch selectable.
- ^b No actuator code. No factory assemblies offered.
- ^c AV-821 linkage (order separately) required for mounting actuators to VB-7xxx globe valve bodies using U-Bolt style Forta.
- ^d Do not use M1500 actuators on VB-7323 three way diverting valves.
- ^e M400/800 DC Power 20W, M1500 Dc Power 30W.

Table-4 Restrictions on Ambient Temperature for Forta Valve Actuators

Fluid Temperature in Valve Body	Maximum Allowable Ambient Temperature ^a
Chilled Water	122°F (50°C)
281°F (138°C)	113°F (45°C)
300°F (149°C)	107°F (42°C)
340°F (171°C)	100°F (38°C)
366°F (186°C)	90°F (32°C)

Note: When installing valve and actuator assemblies, observe the minimum and maximum fluid and ambient temperature limits shown in Table-1, Table-2, and Table-4.

^a Minimum allowable ambient operating temperature 14°F (-10°C)

Table-5 Select Valve/Actuator Combination Having Sufficient Close-off for Application

Valve Body			Close-off Ratings, psi (kPa)			
Two-Way Valves	P Code	Size	M400A- (VB)	M800A- (VB)	M1500A- (VB)	
VB-7211-0-3-P VB-7211-0-4-P VB-7212-0-4-P VB-7213-0-4-P VB-7214-0-4-P VB-7215-0-4-P VB-7221-0-4-P VB-7222-0-4-P VB-7223-0-4-P VB-7224-0-4-P VB-7225-0-4-P VB-7253-0-4-P VB-7263-0-4-P VB-7273-0-4-P VB-7283-0-4-P	-01, -02, -03, -04	1/2" (15 mm)	250 (1712)	250 (1712)	—	
	-05, -06	3/4" (20 mm)	198 (1356)	250 (1712)	—	
	-07, -08	1" (25 mm)	92 (630)	207 (1418)	—	
	-09	1-1/4" (32 mm)	56 (384)	130 (890)	—	
	-10	1-1/2" (40 mm)	37 (253)	88 (603)	177 (1212)	
	-11	2" (50 mm)	19 (130)	48 (329)	98 (671)	
	Three-Way Valves	P Code	Size	M400A (VB)	M800A (VB)	M1500A (VB) ^a
	VB-7312-0-4-P VB-7313-0-4-P VB-7314-0-4-P VB-7315-0-4-P	-02, -04	1/2" (15 mm)	250 (1712)	250 (1712)	—
-06		3/4" (20 mm)	198 (1356)	250 (1712)	—	
-08		1" (25 mm)	92 (630)	207 (1418)	—	
-09		1-1/4" (32 mm)	56 (384)	130 (890)	—	
10		1-1/2" (40 mm)	37 (253)	88 (603)	—	
-11		2" (50 mm)	19 (130)	48 (329)	—	
VB-7323-0-4-P	-04, -06, -08, -09, -10, -11	1/2" to 2"	250 (1712)		Do Not Use ^a	

^a Do not use M1500A on VB-7323 three-way valves.

Factory Assemblies

Table-6 Factory Valve and Actuator Assemblies — Two-Way Valves ^a

Valve Assembly Part Number ^b	P Code ^b	Size	Actuator Model (Actuator Code ^b)		
			M400A-VB (674)	M800A-VB (680)	M1500A-VB (686)
VU-7213-xxx-4-P VU-7253-xxx-4-P VU-7273-xxx-4-P	-01, -02, -03, -04	1/2"	X	X	—
	-05, -06	3/4"	X	X	—
	-07, -08	1"	X	X	—
	-09	1-1/4"	X	X	—
	10	1-1/2"	X	X	X
	11	2"	X	X	X

^a See Table-5 for close-off pressures

^b Insert Actuator Code in third field of assembly part number. Insert P Code in last field of assembly part number.

Table-7 Factory Valve and Actuator Assemblies — Three-Way Mixing Valves ^a

Valve Assembly Part Number ^b	P Code ^b	Size	Actuator Model (Actuator Code ^b)	
			M400A-VB (674)	M800A-VB (680)
VU-7313-xxx-4-P	-02, -04	1/2"	X	X
	-06	3/4"	X	X
	-08	1"	X	X
	-09	1-1/4"	X	X
	10	1-1/2"	X	X
	11	2"	X	X

^a See Table-5 for close-off pressures

^b Insert Actuator Code in third field of assembly part number. Insert P Code in last field of assembly part number.

Table-8 Factory Valve and Actuator Assemblies — Diverting Valves ^a

Valve Assembly Part Number ^b	P Code ^b	Size	Actuator Model (Actuator Code)	
			M400A-VB (674)	M800A-VB (680)
VU-7323-674-4-P	-04	1/2"	X	X
	-06	3/4"	X	X
	-08	1"	X	X
	-09	1-1/4"	X	X
	10	1-1/2"	X	X
	11	2"	X	X

^a See Table-5 for close-off pressures

^b Insert P Code in last field of assembly part number.

Dimensions

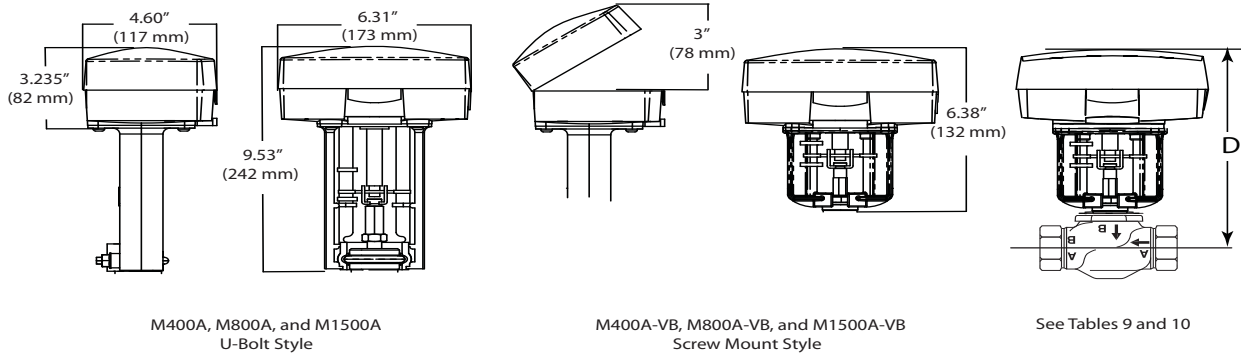
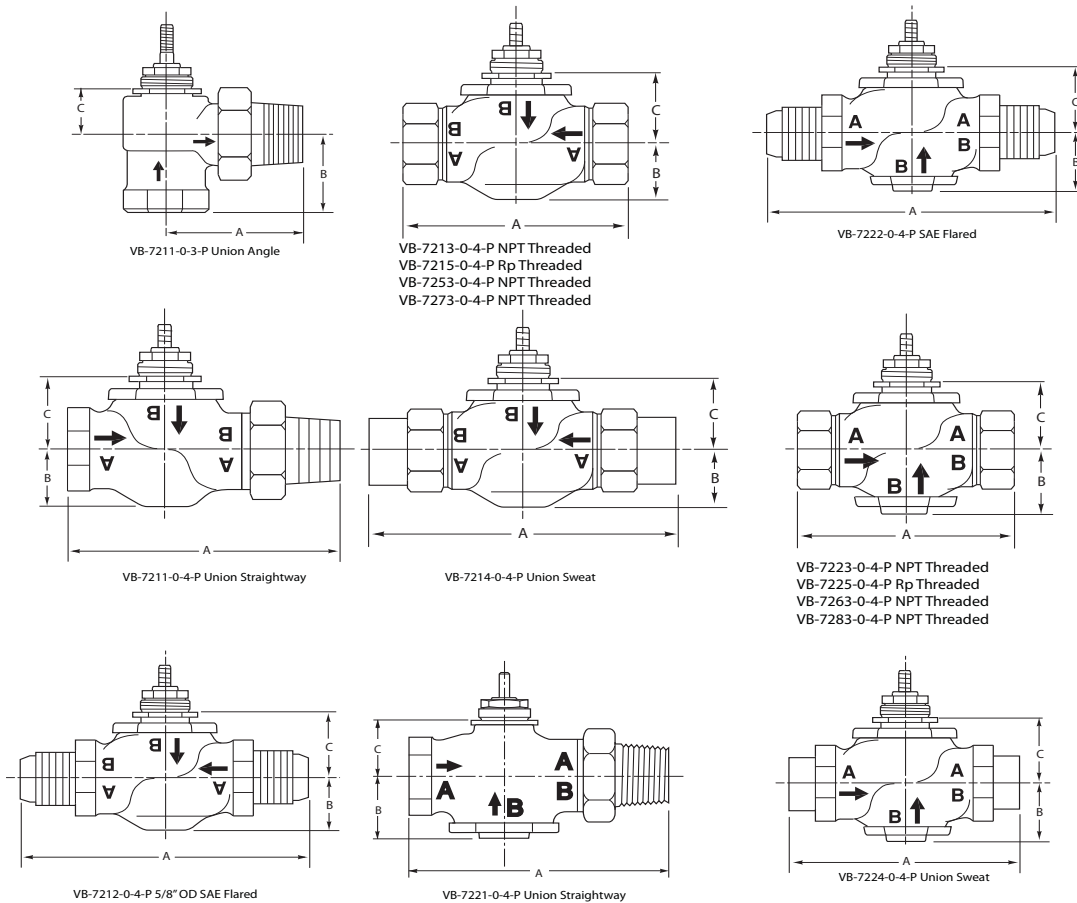

Figure-1 Forta Actuator Dimensions



See Tables 9 and 10

Figure-2 Two Way VB-7xxx Valve Body Dimensions

Table-9 Dimensions — Two-Way Valves (see Figure-1 and Figure-2)

Valve Body Part Number	Size	Dimensions in Inches (mm)				
		A	B	C	U-Bolt Style ^a -D	Screw Mount Style ^a -D
VB-7211-0-3-P	1/2"	3-1/8 (79)	1-5/8 (41)	3/4 (19)	10-9/32 (261)	7-13/32 (188)
	3/4 "	3-5/8 (92)	1-11/16 (43)	15/16 (24)	10-15/32 (266)	7-19/32 (193)
	1 "	4-1/16 (103)	1-15/16 (49)	1-1/4 (32)	10-25/32 (274)	7-29/32 (201)
	1-1/4 "	4-5/16 (110)	2-3/16 (56)	1-11/16 (43)	11-7/32 (285)	8-11/32 (212)
VB-7211-0-4-P	1/2 "	4-3/16 (106)	1-1/16 (27)	1-1/8 (29)	10-21/32 (271)	7-25/32 (198)
	3/4"	4-15/16 (125)	1-1/16 (27)	1-1/8 (29)	10-21/32 (271)	7-25/32 (198)
	1"	6 (152)	1-1/8 (29)	1-3/16 (30)	10-23/32 (272)	7-27/32 (199)
	1-1/4"	6-1/4 (159)	1-3/8 (35)	1-7/16 (37)	10-31/32 (279)	8-3/32 (206)
VB-7212-0-4-P	5/8" O.D.	4 (102)	1-1/16 (27)	1-1/8 (29)	10-21/32 (271)	7-25/32 (198)
VB-7213-0-4-P VB-7215-0-4-P VB-7253-0-4-P VB-7273-0-4-P	1/2" (15 mm)	3 (76)	1-1/16 (27)	1-1/8 (29)	10-21/32 (271)	7-25/32 (198)
	3/4" (20 mm)	3-5/8 (92)	1-1/16 (27)	1-1/8 (29)	10-21/32 (271)	7-25/32 (198)
	1" (25 mm)	4-5/8 (117)	1-1/8 (29)	1-3/16 (30)	10-23/32 (272)	7-27/32 (199)
	1-1/4" (32 mm)	4-5/8 (117)	1-3/8 (35)	1-7/16 (37)	10-31/32 (279)	8-3/32 (206)
	1-1/2 (40 mm)	5-3/8 (137)	1-1/2 (38)	1-7/8 (48)	11-13/32 (290)	8-17/32 (217)
	2"(50 mm)	6-1/8 (156)	1-9/16 (40)	2-1/8(54)	11-21/32 (296)	8-25/32 (223)
VB-7214-0-4-P	1/2"	4-3/16 (106)	1-1/16 (27)	1-1/8 (29)	10-21/32 (271)	7-25/32 (198)
	3/4"	5-7/16 (138)	1-1/16 (27)	1-1/8 (29)	10-21/32 (271)	7-25/32 (198)
	1"	6-5/8 (168)	1-1/8 (29)	1-3/16 (30)	10-23/32 (272)	7-27/32 (199)
	1-1/4"	6-13/16 (173)	1-3/8 (35)	1-7/16 (37)	10-31/32 (279)	8-3/32 (206)
	1-1/2"	8-5/16 (211)	1-1/2 (38)	1-7/8 (48)	11-13/32 (290)	8-17/32 (217)
	2"	9-3/16 (233)	1-9/16 (40)	2-1/8(54)	11-21/32 (296)	8-25/32 (223)
VB-7221-0-4-P	1/2"	4-3/16 (106)	1-1/4 (32)	1-1/8 (29)	10-21/32 (271)	7-25/32 (198)
	3/4"	4-15/16 (125)	1-1/4 (32)	1-1/8 (29)	10-21/32 (271)	7-25/32 (198)
	1"	6 (152)	1-3/4 (45)	1-3/16 (30)	10-23/32 (272)	7-27/32 (199)
	1-1/4"	6-1/4 (159)	1-3/4 (45)	1-7/16 (37)	10-31/32 (279)	8-3/32 (206)
VB-7222-0-4-P	5/8" OD	4 (102)	1-1/4 (32)	1-1/8 (29)	10-21/32 (271)	7-25/32 (198)
VB-7223-0-4-P VB-7225-0-4-P VB-7263-0-4-P VB-7283-0-4-P	1/2" (15 mm)	3-1/16 (78)	1-3/16 (30)	1-1/8 (29)	10-21/32 (271)	7-25/32 (198)
	3/4" (20 mm)	3-5/8 (92)	1-3/16 (30)	1-1/8 (29)	10-21/32 (271)	7-25/32 (198)
	1" (25 mm)	4-5/8 (117)	1-3/4 (44)	1-3/16 (30)	10-23/32 (272)	7-27/32 (199)
	1-1/4" (32 mm)	4-5/8 (117)	1-3/4 (44)	1-7/16 (37)	10-31/32 (279)	8-3/32 (206)
	1-1/2 (40 mm)	5-3/8 (137)	1-13/16 (46)	1-9/16 (40)	11-3/32(282)	8-7/32 (209)
	2" (50 mm)	6-1/8 (156)	2-1/4 (57)	1-5/8 (42)	11-5/32 (283)	8-9/32 (210)
VB-7224-0-4-P	1/2"	4-3/16 (106)	1-1/4 (32)	1-1/8 (29)	10-21/32 (271)	7-25/32 (198)
	3/4"	5-7/16 (138)	1-1/4 (32)	1-1/8 (29)	10-21/32 (271)	7-25/32 (198)
	1"	6-5/8 (168)	1-3/4 (45)	1-3/16 (30)	10-23/32 (272)	7-27/32 (199)
	1-1/4"	6-13/16 (173)	1-3/4 (45)	1-7/16 (37)	10-31/32 (279)	8-3/32 (206)
	1-1/2"	8-5/16 (211)	1-13/16 (45)	1-9/16 (40)	11-3/32(282)	8-7/32 (209)
	2"	9-3/16 (233)	2-1/16 (53)	1-5/8 (42)	11-5/32 (283)	8-9/32 (210)

^a Assembly height, centerline of valve body to top of actuator (see Figure-1). Leave an additional 3" (76 mm) clearance for cover removal.

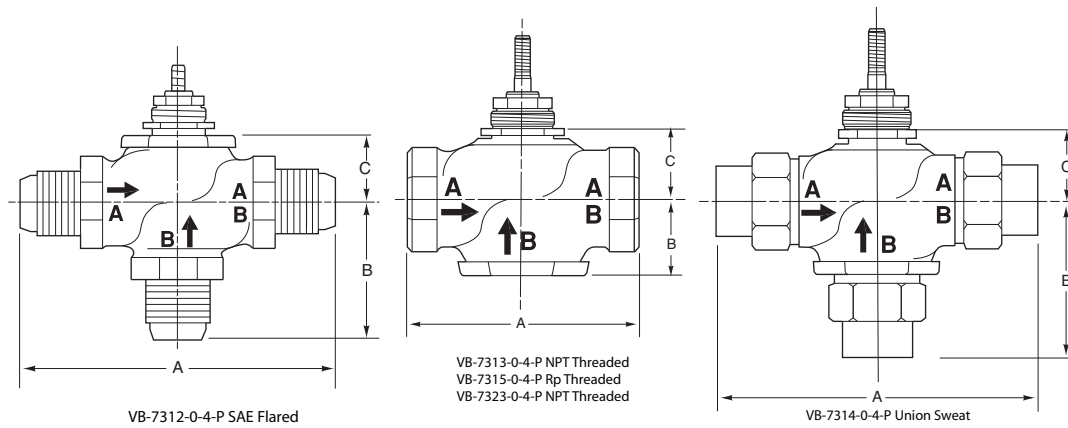

Figure-3 Three-Way VB-73xx Valve Body Dimensions

Table-10 Dimensions — Three-Way Valves (see Figure-1 and Figure-3)

Valve Body Part Number	Size	Dimensions in Inches (mm)				
		A	B	C	U-Bolt Style ^{a-D}	Screw Mount Style ^{a-D}
VB-7312-0-4-P	5/8" OD	4 (102)	2-1/4 (57)	1-1/8 (29)	10-21/32 (271)	7-25/32 (198)
VB-7313-0-4-P VB-7315-0-4-P	1/2" (15 mm)	3-1/16 (76)	1-3/4 (44)	1-1/8 (29)	10-21/32 (271)	7-25/32 (198)
	3/4" (20 mm)	3-5/8 (92)	1-13/16 (46)	1-1/8 (29)	10-21/32 (271)	7-25/32 (198)
	1" (25 mm)	4-5/8 (118)	1-3/4 (44)	1-3/16 (30)	10-23/32 (272)	7-27/32 (199)
	1-1/4" (32 mm)	4-5/8 (118)	1-3/4 (44)	1-7/16 (37)	10-31/32 (279)	8-3/32 (206)
	1-1/2" (40 mm)	5-3/8 (137)	1-13/16 (46)	1-9/16 (40)	11-3/32(282)	8-7/32 (209)
	2" (50 mm)	6-1/8 (156)	2-1/4 (57)	1-5/8 (42)	11-5/32 (283)	8-9/32 (210)
VB-7314-0-4-P	1/2"	4-3/16 (106)	2-5/16 (59)	1-1/8 (29)	10-21/32 (271)	7-25/32 (198)
	3/4"	5-7/16 (138)	2-5/8 (67)	1-1/8 (29)	10-21/32 (271)	7-25/32 (198)
	1"	6-5/8 (168)	3-3/16 (81)	1-3/16 (30)	10-23/32 (272)	7-27/32 (199)
	1-1/4"	6-13/16 (173)	3-7/16 (87)	1-7/16 (37)	10-31/32 (279)	8-3/32 (206)
	1-1/2"	8-5/16 (211)	3-3/4 (95)	1-9/16 (40)	11-3/32(282)	8-7/32 (209)
	2"	9-3/16 (233)	4-3/16 (106)	1-5/8 (42)	11-5/32 (283)	8-9/32 (210)
VB-7323'-0-4-P	1/2"	3-1/16 (76)	1-3/8 (35)	1-1/8 (29)	10-21/32 (271)	7-25/32 (198)
	3/4"	3-5/8 (92)	1-11/16 (43)	1-1/8 (29)	10-21/32 (271)	7-25/32 (198)
	1"	4-5/8 (118)	1-9/16 (40)	1-3/16 (30)	10-23/32 (272)	7-27/32 (199)
	1-1/4"	4-5/8 (118)	1-5/8 (41)	1-7/16 (37)	10-31/32 (279)	8-3/32 (206)
	1-1/2"	5-3/8 (137)	1-11/16 (43)	1-9/16 (40)	11-3/32(282)	8-7/32 (209)
	2"	6-1/8 (156)	1-7/8 (48)	1-5/8 (42)	11-5/32 (283)	8-9/32 (210)

Copyright 2011, Schneider Electric
All brand names, trademarks and registered trademarks are the property of their respective owners. Information contained within this document is subject to change without notice.

Schneider Electric
1354 Clifford Avenue
P.O. Box 2940
Loves Park, IL 61132-2940
www.schneider-electric.com/buildings

